

# Owner's Manual

# SV2000

## Recordable disc

- We strongly recommend for good recording quality:  
TDK DVD+R 4x/8x/16x, SONY DVD+R 4x/8x/16x, MAXELL DVD+R 4x/8x/16x, SONY DVD+RW 4x,  
MAXELL DVD-R 8x/16x, MAXELL DVD-RW 4x
- Discs that have been tested and are proven to be compatible with this recorder:  
VERBATIM DVD+R 8x, VERBATIM DVD+RW 4x, VERBATIM DVD-R 8x, VERBATIM DVD-RW 2x, MAXELL DVD-R 16x, JVC DVD-RW 4X

## DVD Recorder

# WV10D6

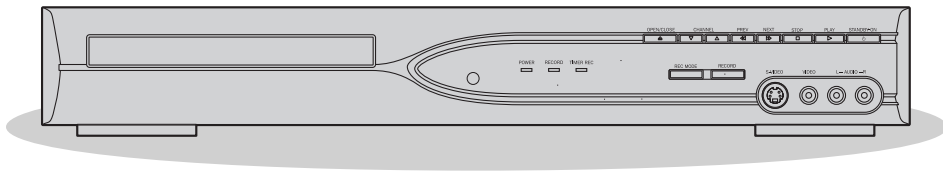

### INSTRUCCIONES EN ESPAÑOL INCLUIDAS

Please read before using this equipment.  
If you need additional operating assistance after reading this owner's manual or to order replacement accessories, please call  
**TOLL FREE : 1-800-518-1180**  
or visit our web site at <http://www.funai-corp.com>

### Connection to a TV (Before you use this unit, you need to complete connections.)

If your TV has AUDIO/VIDEO input jacks, see the section "Connections" on pages 13-15. If not, it is still possible to connect this unit to your TV by using a STEREO AUDIO/VIDEO RF modulator (commercially available). In this case, follow the instructions below.

- 1) The antenna input jack of your TV may have been already occupied. If so, disconnect the RF cable from your TV, and then connect the RF cable to the ANTENNA IN jack of this unit.
- 2) Connect the ANTENNA OUT jack of this unit to your RF modulator (usually marked "ANT IN") by the RF cable.
- 3) Connect your RF modulator to your TV by another RF cable.
- 4) Connect the AUDIO/VIDEO output jacks of this unit to the AUDIO/VIDEO input jacks of your RF modulator by audio and video cables.
- 5) Set your RF modulator's channel 3/4 switch to either 3 or 4, whichever the TV channel is least used in your area. If your RF modulator has a Modulator/Antenna switch, set it according to your RF modulator's manual.
- 6) Turn on your TV and choose the same channel as you set the RF modulator's channel 3/4 switch to.  
For more details, follow the instructions supplied with the RF modulator.

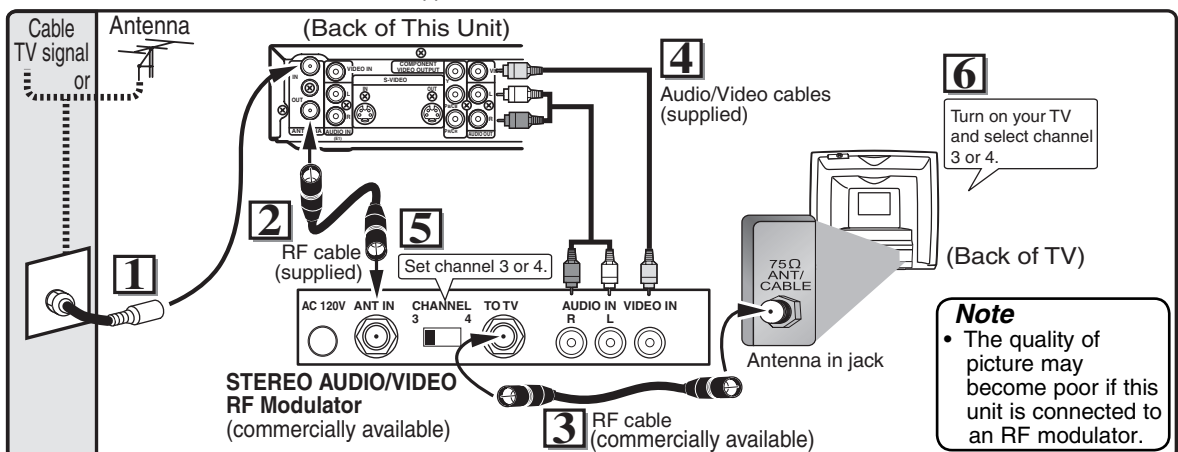

To record a program easily, refer to "Easy DVD recording" on pages 16-17 after connections are completed.  
(You CANNOT record on any copyright protected DVD disc with this unit.)

# Before you start

## Precautions

**WARNING:** TO REDUCE THE RISK OF FIRE OR ELECTRIC SHOCK, DO NOT EXPOSE THIS APPLIANCE TO RAIN OR MOISTURE.



**CAUTION**  
**RISK OF ELECTRIC SHOCK**  
**DO NOT OPEN**



### CAUTION:

TO REDUCE THE RISK OF ELECTRIC SHOCK, DO NOT REMOVE COVER (OR BACK). NO USER SERVICEABLE PARTS INSIDE. REFER SERVICING TO QUALIFIED SERVICE PERSONNEL.



The lightning flash with arrowhead symbol, within an equilateral triangle, is intended to alert the user to the presence of uninsulated "dangerous voltage" within the product's enclosure that may be of sufficient magnitude to constitute a risk of electric shock to persons.



The exclamation point within an equilateral triangle is intended to alert the user to the presence of important operating and maintenance (servicing) instructions in the literature accompanying the appliance.

## Laser Safety

The caution marking is located on the rear of the cabinet.

This unit employs a laser. Only a qualified service person should remove the cover or attempt to service this device, due to possible eye injury.

**CAUTION:** USE OF CONTROLS OR ADJUSTMENTS OR PERFORMANCE OF PROCEDURES OTHER THAN THOSE SPECIFIED HEREIN MAY RESULT IN HAZARDOUS RADIATION EXPOSURE.

**CAUTION:** VISIBLE AND INVISIBLE LASER RADIATION WHEN OPEN AND INTERLOCK DEFEATED. DO NOT STARE INTO BEAM.

**LOCATION:** INSIDE, NEAR THE DECK MECHANISM.

**FCC WARNING-** This equipment may generate or use radio frequency energy. Changes or modifications to this equipment may cause harmful interference unless the modifications are expressly approved in the manual. The user could lose the authority to operate this equipment if an unauthorized change or modification is made.

### RADIO-TV INTERFERENCE

This equipment has been tested and found to comply with the limits for a Class B digital device, pursuant to Part 15 of the FCC Rules. These limits are designed to provide reasonable protection against harmful interference in a residential installation. This equipment generates, uses, and can radiate radio frequency energy and, if not installed and used in accordance with the instructions, may cause harmful interference to radio communications. However, there is no guarantee that interference will not occur in a particular installation. If this equipment does cause harmful interference to radio or television reception, which can be determined by turning the equipment off and on, the user is encouraged to try to correct the interference by one or more of the following measures:

- 1) Reorient or relocate the receiving antenna.
- 2) Increase the separation between the equipment and receiver.
- 3) Connect the equipment into an outlet on a circuit different from that to which the receiver is connected.
- 4) Consult the dealer or an experienced radio/TV technician for help.

**This Class B digital apparatus complies with Canadian ICES-003.**

**Cet appareil numérique de la classe B est conforme à la norme NMB-003 du Canada.**

**CAUTION: TO PREVENT ELECTRIC SHOCK, MATCH WIDE BLADE OF PLUG TO WIDE SLOT, FULLY INSERT.**

**ATTENTION: POUR ÉVITER LES CHOC ÉLECTRIQUES, INTRODUIRE LA LAME LA PLUS LARGE DE LA FICHE DANS LA BORNE CORRESPONDANTE DE LA PRISE ET POUSSER JUSQU'AU FOND.**

### A NOTE ABOUT RECYCLING

This product's packaging materials are recyclable and can be reused. Please dispose of any materials in accordance with your local recycling regulations.

Batteries should never be thrown away or incinerated but disposed of in accordance with your local regulations concerning chemical wastes.

### Make your contribution to the environment!!!

- Used up batteries do not belong in the dust bin.
- You can dispose of them at a collection point for used up batteries or special waste. Contact your council for details.



For Customer Use:

Read carefully the information located at the back of this unit and enter below the Model No. and Serial No. Retain this information for future reference.

Model No. \_\_\_\_\_

Serial No. \_\_\_\_\_

# IMPORTANT SAFEGUARDS

1. Read Instructions - All the safety and operating instructions should be read before the appliance is operated.
2. Retain Instructions- The safety and operating instructions should be retained for future reference.
3. Heed Warnings - All warnings on the appliance and in the operating instructions should be adhered to.
4. Follow Instructions - All operating and use instructions should be followed.
5. Cleaning - Unplug this product from the wall outlet before cleaning. Do not use liquid cleaners or aerosol cleaners. Use a damp cloth for cleaning.  
EXCEPTION: A product that is meant for uninterrupted service and, that for some specific reason, such as the possibility of the loss of an authorization code for a CATV converter, is not intended to be unplugged by the user for cleaning or any other purpose, may exclude the reference to unplugging the appliance in the cleaning description otherwise required in item 5.
6. Attachments - Do not use attachments not recommended by the product manufacturer as they may cause hazards.
7. Water and Moisture- Do not use this product near water, for example, near a bath tub, wash bowl, kitchen sink, or laundry tub, in a wet basement, or near a swimming pool, and the like.
8. Accessories - Do not place this product on an unstable cart, stand, tripod, bracket, or table. The product may fall, causing serious injury to a child or adult, and serious damage to the appliance. Use only with a cart, stand, tripod, bracket, or table recommended by the manufacturer, or sold with the product. Any mounting of the appliance should follow the manufacturer's instructions and should use a mounting accessory recommended by the manufacturer. An appliance and cart combination should be moved with care. Quick stops, excessive force, and uneven surfaces may cause the appliance and cart combination to overturn.
9. Ventilation - Slots and openings in the cabinet are provided for ventilation and to ensure reliable operation of the product and to protect it from overheating, and these openings must not be blocked or covered. The openings should never be blocked by placing the product on a bed, sofa, rug, or other similar surface. This product should not be placed in a built-in installation such as a bookcase or rack unless proper ventilation is provided or the manufacturer's instructions have been adhered to.
10. Power Sources - This product should be operated only from the type of power source indicated on the marking label. If you are not sure of the type of power supply to your home, consult your appliance dealer or local power company. For products intended to operate from battery power, or other sources, refer to the operating instructions.
11. Grounding or Polarization - This product is equipped with a polarized alternating-current line plug (a plug having one blade wider than the other). This plug will fit into the power outlet only one way. This is a safety feature. If you are unable to insert the plug fully into the outlet, try reversing the plug. If the plug should still fail to fit, contact your electrician to replace your obsolete outlet. Do not defeat the safety purpose of the polarized plug.
12. Power Cord Protection - Power supply cords should be routed so that they are not likely to be walked on or pinched by items placed upon or against them, paying particular attention to cords at plugs, convenience receptacles, and the point where they exit from the appliance.
13. Outdoor Antenna Grounding - If an outside antenna or cable system is connected to the product, be sure the antenna or cable system is grounded so as to provide some protection against voltage surges and built-up static charges. Article 810 of the National Electrical Code, ANSI/

NFPA No. 70, provides information with regard to proper grounding of the mast and supporting structure, grounding of the lead-in wire to an antenna discharge unit, size of grounding conductors, location of antenna-discharge unit, connection to grounding electrodes, and requirements for the grounding electrode. (Fig. A)

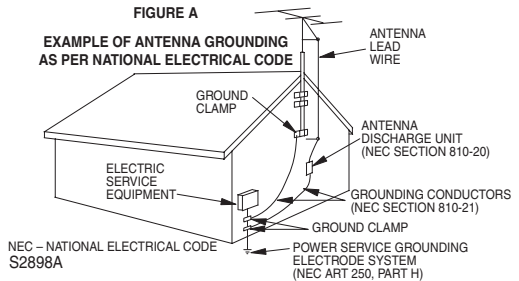

14. Lightning - For added protection for this product during a lightning storm, or when it is left unattended and unused for long periods of time, unplug it from the wall outlet and disconnect the antenna or cable system. This will prevent damage to the product due to lightning and power-line surges.
15. Power Lines - An outside antenna system should not be located in the vicinity of overhead power lines or other electric light or power circuits, or where it can fall into such power lines or circuits. When installing an outside antenna system, extreme care should be taken to keep from touching such power lines or circuits as contact with them might be fatal.
16. Overloading - Do not overload wall outlets and extension cords as this can result in a risk of fire or electric shock.
17. Object and Liquid Entry - Never push objects of any kind into this product through any openings as they may touch dangerous voltage points or short-out parts that could result in a fire or electric shock. Never spill liquid of any kind on the product.
18. Servicing - Do not attempt to service this product yourself as opening or removing covers may expose you to dangerous voltage or other hazards. Refer all servicing to qualified service personnel.
19. Damage Requiring Service - Unplug this product from the wall outlet and refer servicing to qualified service personnel under the following conditions:
  - a. When the power-supply cord or plug is damaged.
  - b. If liquid has been spilled, or objects have fallen into the product.
  - c. If the product has been exposed to rain or water.
  - d. If the product does not operate normally by following the operating instructions. Adjust only those controls that are covered by the operating instructions as an improper adjustment of other controls may result in damage and will often require extensive work by a qualified technician to restore the product to its normal operation.
  - e. If the product has been dropped or damaged in any way.
  - f. When the product exhibits a distinct change in performance this indicates a need for service.
20. Replacement Parts - When replacement parts are required, be sure the service technician has used replacement parts specified by the manufacturer or have the same characteristics as the original part. Unauthorized substitutions may result in fire, electric shock or other hazards.
21. Safety Check - Upon completion of any service or repairs to this product, ask the service technician to perform safety checks to determine that the product is in proper operating condition.
22. Heat - This product should be situated away from heat sources such as radiators, heat registers, stoves, or other products (including amplifiers) that produce heat.

PORTABLE CART WARNING  
(Symbol provided by RETAC)



# Before you start

## Precautions (cont'd)

### Installation Location

For safety and optimum performance of this unit:

- Install the unit in a horizontal and stable position. Do not place anything directly on top of the unit. Do not place the unit directly on top of the TV.
- Shield it from direct sunlight and keep it away from sources of intense heat. Avoid dusty or humid places. Avoid places with insufficient ventilation for proper heat dissipation. Do not block the ventilation holes on the sides of the unit. Avoid locations subject to strong vibration or strong magnetic fields.

### Avoid the Hazards of Electrical Shock and Fire

- Do not handle the power cord with wet hands.
- Do not pull on the power cord when disconnecting it from AC wall outlet. Grasp it by the plug.
- If, by accident, water is spilled on this unit, unplug the power cord immediately and take the unit to our Authorized Service Center for servicing.

### Moisture Condensation Warning

Moisture condensation may occur inside the unit when it is moved from a cold place to a warm place or after heating a cold room or under conditions of high humidity. Do not use this unit at least for 2 hours until its inside gets dry.

### About Copyright

Unauthorized copying, broadcasting, public performance and lending of discs are prohibited. This product incorporates copyright protection technology that is protected by U.S. patents and other intellectual property rights. Use of this copyright protection technology must be authorized by Macrovision, and is intended for home and other limited viewing uses only unless otherwise authorized by Macrovision. Reverse engineering or disassembly is prohibited.

### Notice for progressive scan output

Consumers should note that not all high definition television sets are fully compatible with this product and may cause artifacts to be displayed in the picture. In case of picture problems with 525 progressive scan output, it is recommended that the user switch the connection to the 'standard definition' output. If there are questions regarding your TV set compatibility with this 525p DVD recorder, please contact our customer service center.

### Supplied Accessory

- Remote control (NB086UD) with two AA batteries
- RF cable (WPZ0901TM002)
- Audio/Video cables (WPZ0102TM015 or WPZ0102LTE01)
- Owner's Manual (1VMN23108)
- Quick Guide (1VMN23109)

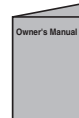
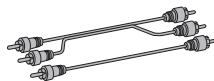
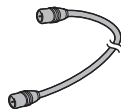



# Before you start

## Precautions (cont'd)

### Maintenance

#### SERVICING

- Please refer to relevant topics on “Troubleshooting” on pages 71-74 before returning the product.
- If this unit becomes inoperative, do not try to correct the problem by yourself. There are no user-serviceable parts inside. Turn off, unplug the power plug and please call our help line mentioned on the front page to locate an Authorized Service Center.

#### CLEANING THE CABINET

- Use a soft cloth slightly moistened with a mild detergent solution. Do not use a solution containing alcohol, spirits, ammonia or abrasive.

#### CLEANING DISCS

- When a disc becomes dirty, clean it with a cleaning cloth. Wipe the disc from the center to out. Do not wipe in a circular motion.
- Do not use solvents such as benzine, thinner, commercially available cleaners, detergent, abrasive cleaning agents or antistatic spray intended for analogue records.

#### CLEANING THE DISC LENS

- If this unit still does not perform properly although you refer to the relevant sections and to “Troubleshooting” in this Owner’s Manual, the laser optical pickup unit may be dirty. Consult your dealer or an Authorized Service Center for inspection and cleaning of the laser optical pickup unit.

#### DISC HANDLING

- Handle the discs so that fingerprints and dust do not adhere to the surfaces of the discs.
- Always store the disc in its protective case when it is not used.

#### IR SIGNAL CHECK

If the remote control does not work properly, you can test if the remote control sends out the infrared signal with AM radio or a digital camera (including built-in camera of cellular phone). It will help to define the cause of malfunction.

##### • With an AM radio:

Tune an AM radio to a station with no broadcasting. Press a button on remote control toward the radio. Sound will be fluttering when you press any key and the radio receives the signal. This means the remote control unit is working.

##### • With a digital camera (including built-in camera of cellular phone):

Direct a digital camera to remote control, press and hold a button on remote control. If infrared light appears through digital camera, the remote is working.

Manufactured under license from Dolby Laboratories. “Dolby” and the double-D symbol are trademarks of Dolby Laboratories.

#### Dolby Digital Recording

“Dolby® Digital Recording enables consumers to record high-quality video with stereo sound on recordable DVD discs. The technology, when utilized instead of PCM recording, also saves recordable disc space, allowing for higher video resolution or extended recording time on each DVD. DVDs created using Dolby Digital Recording will play back on all DVD-Video players.”

**Note:** This is true when the players are compatible with actual recordable DVD discs.

# Before you start

## Table of contents

<b>Before you start</b> .....	<b>2</b>	Playing discs using the title menu .....	41
<b>Precautions</b> .....	<b>2</b>	Pause .....	41
<b>Important Safeguards</b> .....	<b>3</b>	<b>Special playback</b> .....	<b>42</b>
<b>Table of contents</b> .....	<b>6</b>	Resume play .....	42
<b>Features</b> .....	<b>7</b>	Fast forward / Fast reverse .....	42
Symbols used in this Owner's Manual .....	7	Skipping TV commercials during play .....	42
<b>Functional overview</b> .....	<b>8</b>	Rapid play .....	43
Installing batteries in the remote control .....	11	Step by step playback .....	43
Using a remote control .....	11	Slow forward / Slow reverse play .....	43
DISPLAY menu .....	11	Zoom .....	44
Setup menus .....	12	Marker Setup .....	44
<b>Connections</b> .....	<b>13</b>	<b>Search</b> .....	<b>45</b>
<b>Connection to a TV</b> .....	<b>13</b>	Title/Chapter search .....	45
<b>Connection to a cable box or satellite box</b> .....	<b>14</b>	Track search .....	46
<b>Connection to an Audio System</b> .....	<b>15</b>	Time search .....	46
<b>Getting started</b> .....	<b>16</b>	<b>Repeat/Random/Program playback</b> .....	<b>47</b>
<b>Easy DVD recording</b> .....	<b>16</b>	Repeat playback .....	47
<b>Initial setting</b> .....	<b>18</b>	Random playback .....	47
<b>Channel setting</b> .....	<b>18</b>	Program playback .....	48
Getting channels automatically .....	18	<b>Selecting the format of audio and video</b> .....	<b>48</b>
Adding/deleting channels .....	19	Switching subtitles .....	48
<b>Selecting the TV stereo or SAP</b> .....	<b>20</b>	Switching audio soundtrack .....	49
<b>Setting the clock</b> .....	<b>21</b>	Switching virtual surround system .....	49
Auto Clock Setting .....	21	Switching camera angles .....	50
Manual Clock Setting .....	22	Reducing block noise .....	50
Setting the Daylight Saving Time .....	23	<b>Editing</b> .....	<b>51</b>
<b>Selecting the TV aspect ratio</b> .....	<b>23</b>	<b>Information on disc editing</b> .....	<b>51</b>
<b>Recording</b> .....	<b>24</b>	Guide to a title list .....	51
<b>Information on DVD recording</b> .....	<b>24</b>	Editing discs .....	51
Information .....	24	Editing discs (Setup menu) .....	51
Recordable disc .....	24	<b>Editing discs</b> .....	<b>52</b>
Recording mode .....	24	Deleting titles .....	52
Making discs playable in other DVD player (Finalize/Make Edits Compatible) .....	25	Putting names on titles .....	53
<b>Before recording</b> .....	<b>26</b>	Setting chapter marks .....	54
Replacing disc menu .....	26	Clearing chapter marks .....	54
Setting for Auto Chapter .....	26	Hiding chapters .....	56
<b>Basic recording</b> .....	<b>27</b>	Setting pictures for thumbnails .....	57
<b>One-touch Timer Recording</b> .....	<b>28</b>	Dividing a title .....	58
<b>Timer Recording</b> .....	<b>29</b>	<b>Editing discs (Setup menu)</b> .....	<b>59</b>
Hints for Timer Recording .....	31	Putting name on disc .....	59
<b>Overwriting an existing title</b> .....	<b>32</b>	Setting or releasing disc protect .....	60
Overwriting from the beginning of the title .....	32	Erasing disc .....	62
Overwriting in the middle of the title .....	32	Making edits compatible .....	62
Hints for Overwriting .....	33	<b>Changing the Setup menu</b> .....	<b>63</b>
<b>Settings for an external source</b> .....	<b>34</b>	<b>Tour of the Setup menu</b> .....	<b>63</b>
Connection to an external source .....	34	<b>Language setting</b> .....	<b>64</b>
Recording from an external source .....	35	<b>Display setting</b> .....	<b>65</b>
<b>Setting a disc to protect</b> .....	<b>35</b>	<b>Audio setting</b> .....	<b>66</b>
<b>Playing the discs in other DVD players</b> .....	<b>36</b>	<b>Video setting</b> .....	<b>68</b>
Finalizing a disc .....	36	<b>Settings for Parental lock level</b> .....	<b>69</b>
Auto finalizing .....	37	<b>Settings for PBC (Playback Control)</b> .....	<b>70</b>
<b>Playing discs</b> .....	<b>38</b>	<b>Others</b> .....	<b>71</b>
<b>Information on DVD play</b> .....	<b>38</b>	<b>Troubleshooting</b> .....	<b>71</b>
Guide to displays .....	38	<b>Language code</b> .....	<b>74</b>
<b>Basic playback</b> .....	<b>39</b>	<b>Glossary</b> .....	<b>75</b>
Playback .....	39	<b>Frequently Asked Questions</b> .....	<b>75</b>
Playing MP3 disc .....	40	<b>Specifications</b> .....	<b>76</b>
Playing discs using the disc menu .....	41	<b>Español</b> .....	<b>77</b>
		<b>Limited Warranty</b> .....	<b>Back Cover</b>

# Before you start

## Features

This DVD unit not only plays DVDs and CDs but also offers features for you to record to DVD discs and edit them after that.

The following features are offered with this unit.

### Recording

This unit is compatible with DVD+RW/DVD-RW, which is rewritable repeatedly and DVD+R/DVD-R, which is available for recording once. You can choose either one for your convenience. Even if you choose DVD-RW/DVD-R discs, these discs will automatically be recorded in the DVD+VR mode.

#### Up to 8 program recording:

You can program the unit to record up to 8 programs, with in a month in advance. Daily or weekly program recordings are also available.

#### One-touch Timer Recording:

You can easily set a recording time as you prefer. Every time [RECORD] or [REC] is pressed during recording, the recording time will be increased by 30 minutes up to 6 hours. The recording automatically stops when the recording time you set is reached.

#### Automatic Chapter mark setting:

Chapter marks will be put on recordings as you set in the Setup menu before attempting to record.

#### Automatic Title list making:

The unit makes title list with the index automatically.

#### Left channel stereo recording:

This unit can record the sound of the Left channel monaural input as Left and Right channels automatically (the input from the EXT2 only).

### Play

#### Theater surround sound in your home:

When connecting the unit to an amplifier or a decoder which is compatible with Dolby Digital, you are allowed to experience the theater surround sound from discs with surround sound system.

#### Quick search for what you want to watch:

You can easily find the part you want to watch using the search function. Search for a desired point on a disc by title, chapter or time.

#### Virtual Surround System:

You can enjoy stereophonic space through your exciting 2 channel stereo system.

#### Playing back on MP3 disc:

You can enjoy MP3 files which are recorded on CD-RW/R.

### Editing

#### Deleting titles:

You can delete titles which you do not need anymore.

#### Putting names on titles:

You can put your favorite names on titles.

#### Setting / Clearing chapter marks:

You can set / clear chapter marks on titles.

#### Hiding unwanted chapters:

To keep others from playing back some chapters without permission, you can hide chapters.

#### Setting pictures for thumbnails:

You can change pictures for thumbnails.

#### Dividing titles (DVD+RW/DVD-RW only):

You can divide a title into two or more.

#### Putting name on disc:

You can put your favorite disc name.

### Compatibility

#### Available for playing discs on a regular DVD player:

Recorded discs can be played on regular DVD players, including computer DVD drives compatible with DVD-Video playback. You will need to finalize the discs recorded on DVD+R/DVD-RW/DVD-R discs to play in other DVD players.

### Others











#### Progressive Scan system

Unlike conventional interlace scanning, the progressive scan system provides less flickering and images in higher resolution than that of traditional television signals.

## Symbols used in this Owner's Manual

To specify for what disc type each function is, we put the following symbols at the beginning of each item to operate.

\*DVD-RW (VR mode) disc is not played in this unit.

Symbol	Description
	Refers to DVD-Video discs
	Refers to DVD+RW discs
	Refers to DVD+R discs
	Refers to DVD+R DL discs
	Refers to DVD-RW discs recorded with +VR mode
	Refers to DVD-R discs recorded with +VR mode
	Refers to DVD-RW discs (Video mode, Finalized)
	Refers to DVD-R discs (Video mode, Finalized)
	Refers to Audio CDs
	Refers to CD-RW/R discs with MP3 files
	Refers to Video CDs

# Before you start

## Functional overview

### Front Panel

\*The unit can also be turned on by pressing this button.

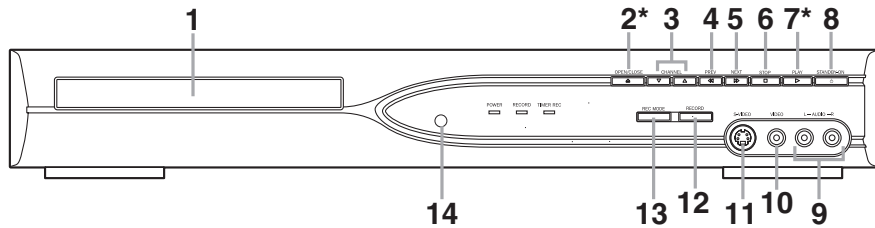

- 1. Disc tray**  
Place a disc when opening the disc tray.
- 2. OPEN/CLOSE ▲ button\***  
Press to open or close the disc tray.
- 3. CHANNEL ▼ / ▲ buttons**  
Press to change the channel up and down.
- 4. PREV ◀◀ button**  
During playback, press to return to the beginning of the current chapter or track.  
During playback, press and hold for 1.5 seconds to fast reverse.  
Or when playback is paused, press to play reverse step by step.  
When playback is paused, press and hold for 1.5 seconds to play slow reverse.
- 5. NEXT ▶▶ button**  
During playback, press to skip to the next chapter or track.  
During playback, press and hold for 1.5 seconds to fast forward.  
Or when playback is paused, press to play forward step by step.  
When playback is paused, press and hold for 1.5 seconds to play slow forward.
- 6. STOP ■ button**  
Press to stop playback or recording.
- 7. PLAY ▶ button\***  
Press to start or resume play.
- 8. STANDBY-ON ☺ button**  
Press to turn the unit on and off.  
If timer programmings have been set, press to set the unit in timer-standby mode.
- 9. AUDIO input jacks (EXT2)**  
Use to connect external equipment with a standard audio cable.
- 10. VIDEO input jack (EXT2)**  
Use to connect external equipment with a standard video cable.
- 11. S-VIDEO input jack (EXT2)**  
Use to connect the S-Video output of external equipment with an S-Video cable.
- 12. RECORD button**  
Press once to start a recording. Press repeatedly to start the One-touch Timer Recording.
- 13. REC MODE button**  
Press to switch the recording speed.
- 14. Remote control sensor**  
Receive signals from your remote control so that you can control the unit from a distance.

### Front Panel Indicator Guide

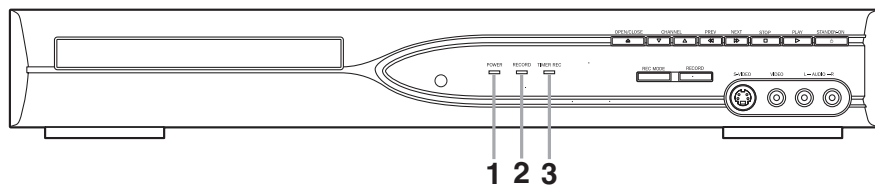

- 1. POWER indicator**  
Light up when power is on.
- 2. RECORD indicator**  
Light up when recording function works.
- 3. TIMER REC indicator**  
Light up when Timer Programming is set.  
Light up during One-touch Timer Recording.  
Flash when all Timer Programmings have been finished, or when a program cannot be performed by some reason.

# Before you start

## Functional overview (cont'd)

### Rear Panel

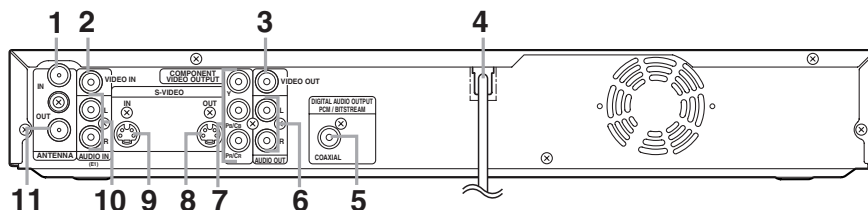

- 1. ANTENNA IN jack**  
Use to connect an antenna.
- 2. VIDEO IN jack (EXT1)**  
Use to connect external equipment with a standard video cable.
- 3. VIDEO OUT jack**  
Use to connect a TV monitor, AV receiver or other equipment with a standard video cable.
- 4. AC Power Cord**  
Connect to a standard AC outlet to supply power to this unit.
- 5. COAXIAL DIGITAL AUDIO OUTPUT jack**  
Use to connect an AV receiver, Dolby Digital decoder or other equipment with a coaxial digital input jack with a digital coaxial cable.
- 6. AUDIO OUT jacks**  
Use to connect a TV monitor, AV receiver or other equipment with a standard audio cable.
- 7. COMPONENT VIDEO OUTPUT jacks**  
Use to connect a TV monitor with component video inputs with a component video cable.
- 8. S-VIDEO OUT jack**  
Use to connect the S-Video input of a TV monitor, AV receiver or other equipment with an S-Video cable.
- 9. S-VIDEO IN jack (EXT1)**  
Use to connect the S-Video output of external equipment with an S-Video cable.
- 10. AUDIO IN jacks (EXT1)**  
Use to connect external equipment with a standard audio cable.
- 11. ANTENNA OUT jack**  
Use to connect an antenna cable to pass the signal from the TV ANTENNA IN to your TV monitor.

#### Note

- Do not touch the inner pins of the jacks on the rear panel. Electrostatic discharge may cause permanent damage to the unit.
- This unit does not have the RF modulator.

# Before you start

## Functional overview (cont'd)

### Remote Control

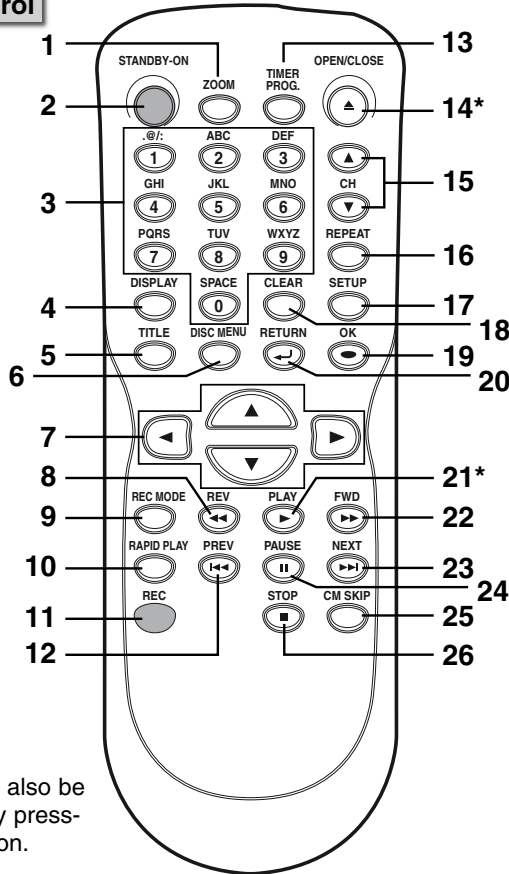

(\*) The unit can also be turned on by pressing this button.

#### 1. ZOOM button

During playback, press to enlarge the picture on the screen.

#### 2. STANDBY-ON button

Press to turn the unit on and off. If timer programmings have been set, press to set the unit in timer-standby mode.

#### 3. Number/Character buttons

Press to select channel numbers. Press to select a title/chapter/track on display.

Press to enter values for the settings in the Setup menu. Or press to enter title names.

#### 4. DISPLAY button

Press to display the Display menu on or off.

#### 5. TITLE button

Press to display the Title list.

#### 6. DISC MENU button

Press to display the Disc menu.

#### 7. Cursor ▲ / ▼ / ◀ / ▶ buttons

Press to select items or settings.

#### 8. REV ◀◀ button

During playback, press to fast reverse.

Or when playback is paused, press to play slow reverse.

#### 9. REC MODE button

Press to switch the recording mode.

#### 10. RAPID PLAY button

During playback, press to playback in a slightly faster/slower mode with keeping the audio quality.

#### 11. REC button

Press once to start a recording. Press repeatedly to start the One-Touch Timer Recording.

#### 12. PREV ◀◀ button

During playback, press to return to the beginning of the current chapter or track. Or when playback is paused, press to play reverse step by step.

#### 13. TIMER PROG. button

Press to display the Timer programming list.

#### 14. OPEN/CLOSE ▲ button\*

Press to open or close the disc tray.

#### 15. CH ▲ / ▼ buttons

Press to change the channel up and down.

#### 16. REPEAT button

Press to display the Repeat menu.

#### 17. SETUP button

Press to display the Setup menu.

During DVD playback, press and hold for more than 3 seconds to switch the progressive scanning mode to the interlace mode.

#### 18. CLEAR button

Press to clear the password once entered or to cancel the programming for CD or to clear the selecting marker number in the Edit menu or to clear the program once entered in the Timer Programming list, etc.

#### 19. OK button

Press to confirm or select menu items.

#### 20. RETURN ↵ button

Press to return to the previously displayed menu screen.

#### 21. PLAY ► button\*

Press to start or resume play.

#### 22. FWD ►► button

During playback, press to play fast forward.

Or when playback is paused, press to play slow forward.

#### 23. NEXT ►►| button

During playback, press to skip to the next chapter or track.

Or when playback is paused, press to play forward step by step.

#### 24. PAUSE || button

Press to pause play or recording.

#### 25. CM SKIP button

During playback, press to skip 30 seconds.

#### 26. STOP ■ button

Press to stop playback or recording.

Press to exit from the Title list.



# Before you start

## Functional overview (cont'd)

### Installing batteries in the remote control

Install two "AA" size batteries (supplied) matching the polarity indicated inside battery compartment of the remote control.

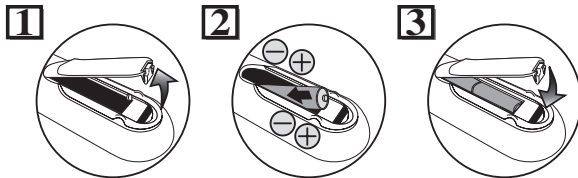

#### Note:

Incorrect use of batteries can result in hazards such as leakage and bursting. Please observe the following:

- Do not mix new and old batteries together.
- Do not use different kinds of batteries together, although they may look similar, different batteries may have different voltages.
- Make sure that the plus and minus ends of each battery match the indications in the battery compartment.
- Remove batteries from equipment that is not going to be used for a month or more.
- When disposing of used batteries, please comply with governmental regulations or environmental public instruction's rules that apply in your country or area.
- Do not recharge, short-circuit, heat, burn or disassemble batteries.

### Using a remote control

Keep in mind the following when using the remote control:

- Make sure that there is no obstacle between the remote control and the remote sensor on the unit.
- Remote operation may become unreliable if strong sunlight or fluorescent light is shining on the remote sensor of the unit.
- Remote control for different devices can interfere with each other. Avoid using remote control for other equipment located close to the unit.
- Replace the batteries when you notice a fall off in the operating range of the remote control.
- The maximum operable ranges from the unit are as follows.
  - **Line of sight:** approx. 23 feet (7m)
  - **Either side of the center:** approx. 16 feet (5m) within 30°
  - **Above:** approx. 16 feet (5m) within 15°
  - **Below:** approx. 10 feet (3m) within 30°

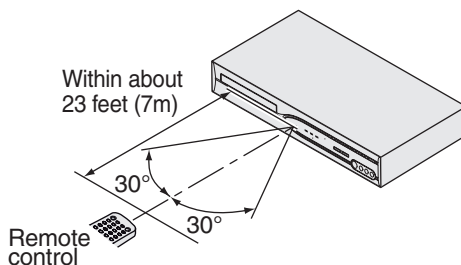

### Guide to Displays on screen menu

This unit uses the following on screen menu for most operations: Setup menu and Title list, and Display menu. They allow you to change the playing status of the disc during playback. The Display menu also gives you information on the status of the disc.

### DISPLAY menu

Press **[DISPLAY]** to call up the Display menu. This menu will give you the information on the playing disc. Some operations are available while disc is playing.

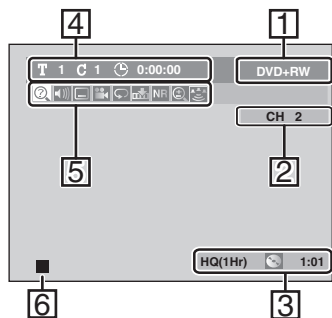

1. Indicates a disc type and a format mode (Format mode is displayed with DVD-RW/DVD-R (Video mode) disc inserted).  
**NOTE:** In some descriptions on this manual, only one disc type is indicated as an example.
2. Indicates a channel number.
3. Indicates a recording mode and possible recording time left.
4. Indicates a title number, chapter number and the time lapse of disc play.

5. Each icon means:

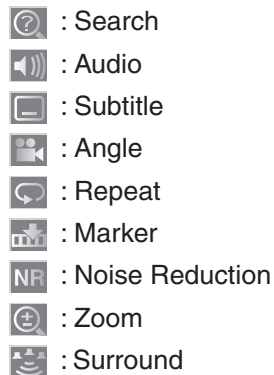

6. Indicates current disc status.

# Before you start

## Functional overview (cont'd)

### Setup menus

Press **[SETUP]** to display the Setup menu. Then using **[▲ / ▼]**, select a menu and press **[OK]** to display the menu. These menus provide entries to all main functions of the unit.

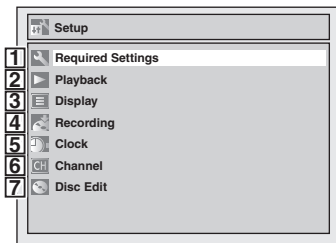

#### 1. Required Settings:

To set up the required settings.

#### 2. Playback:

To set up the unit to play discs as you prefer.

#### 3. Display:

To set up the OSD screen as you prefer.

#### 4. Recording:

To set up the unit to record to discs as you prefer.

#### 5. Clock:

To set up the clock of the unit as you need.

#### 6. Channel:

To adjust the channel setting of the unit as you prefer.

#### 7. Disc Edit / CD Playback Mode:

“Disc Edit” is only available with disc recorded in this unit. (DVD+VR mode)

“CD Playback Mode” is available only when an Audio CD disc, a Video CD or a CD-RW/R disc with MP3 files is inserted into the unit.

<Disc Edit menu (DVD+RW)>

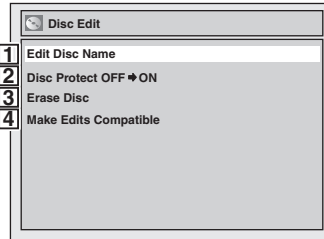

<Disc Edit menu (DVD-RW)>

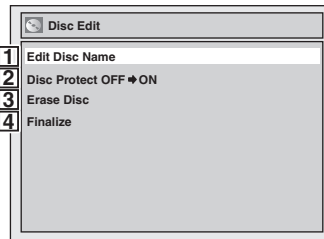

<Disc Edit menu (DVD+R/DVD-R)>

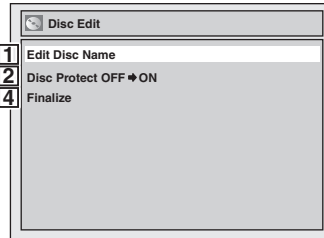

<CD Playback Mode menu>

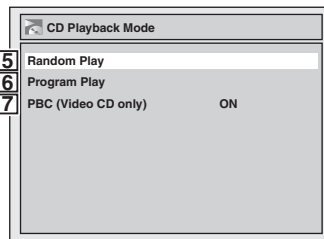

#### 1. Edit Disc Name:

Allows you to rename the disc formatted with DVD+VR.

#### 2. Disc Protect :

Allows you to protect a disc from accidental editing or recording.

#### 3. Erase Disc (DVD+RW/DVD-RW only):

Allows you to erase all contents in the disc and format it.

#### 4. Make Edits Compatible (DVD+RW only):

Allows you to make edits possible to play discs in other units after editing titles.

#### Finalize (DVD+R/DVD-R/DVD-RW only):

Allows you to finalize a disc containing recorded titles.

#### 5. Random Play:

Allows you to activate the random playback feature.

#### 6. Program Play (Audio CD/ Video CD only):

Allows you to activate the programmed playback feature.

#### 7. PBC (Video CD only)

Allows you to select images or information on the menu screen by activating PBC (Playback control) function.

# Connections

## Connection to a TV

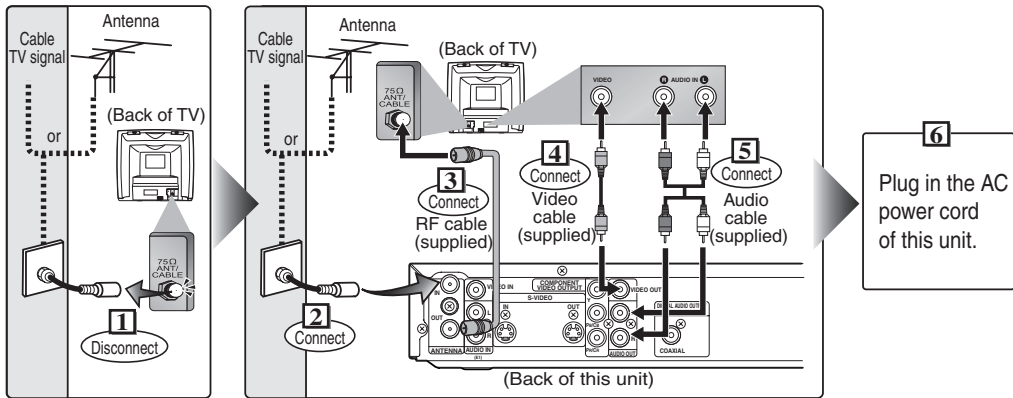

Make one of the following connections, depending on the capabilities of your existing equipment.

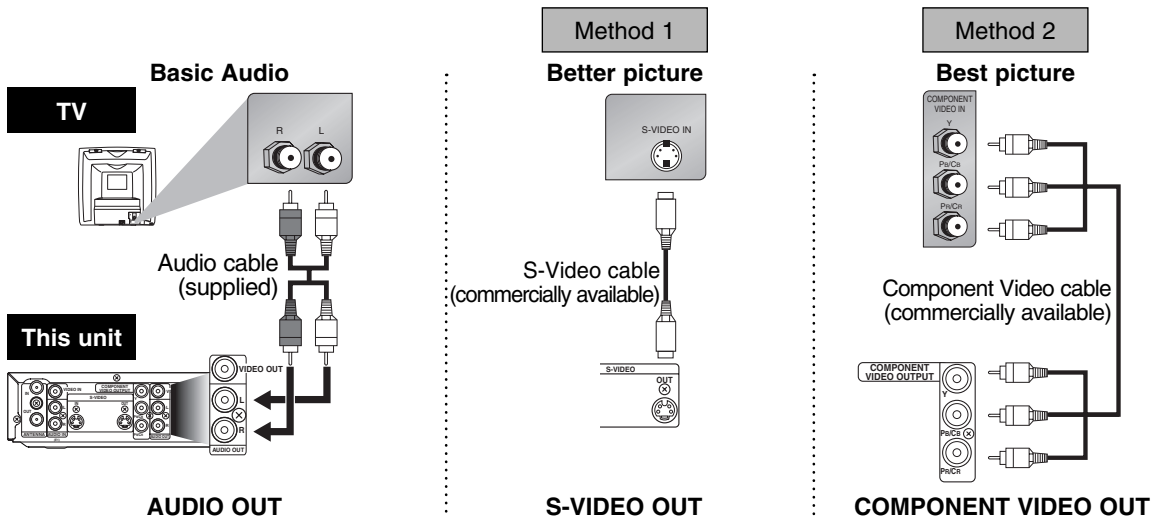

### After you have completed connections

- Switch the input selector on your TV to an appropriate external input channel (usually near channel 0). Press a button on the TV's original remote control that selects an external input channel until the DVD recorder's picture appears. Check your TV owner's manual for details.

### Input Mode Names for Common TV Brands

Admiral	AUX	LXI-Series	00	Sharp	00
Curtis Mathis	LINE1, LINE2, 00, 90, 91, 92, 93	Magnavox	AUX CHANNEL	Sony	VIDEO1, VIDEO2, VIDEO3
GE	INPUT, TV/VCR, 00, 90, 91, 92, 93	Panasonic	TV/VIDEO	Toshiba	TV/GAME
Hitachi	INPUT, AUX	RCA	INPUT, TV/VCR, 00, 90, 91, 92, 93	Zenith	00
JVC	VIDEO, VIDEO1, VIDEO2, VIDEO3	Samsung	TV/VIDEO		
Kenwood	AUX	Sanyo	VIDEO		

### Note

- Connect this unit directly to the TV. If the A/V cables are connected to a VCR, pictures may be distorted due to the copy protection system.
- When Progressive Scan mode is selected, no video signal will be output from the VIDEO OUT or S-VIDEO OUT jack.

### To set progressive scan mode, refer to page 68

- This unit is compatible with the Progressive Scan System. The feature provides you with the higher definition images than the traditional output system does. To utilize this feature, you must set Progressive Scan mode to "ON".

# Connections

## Connection to a cable box or satellite box

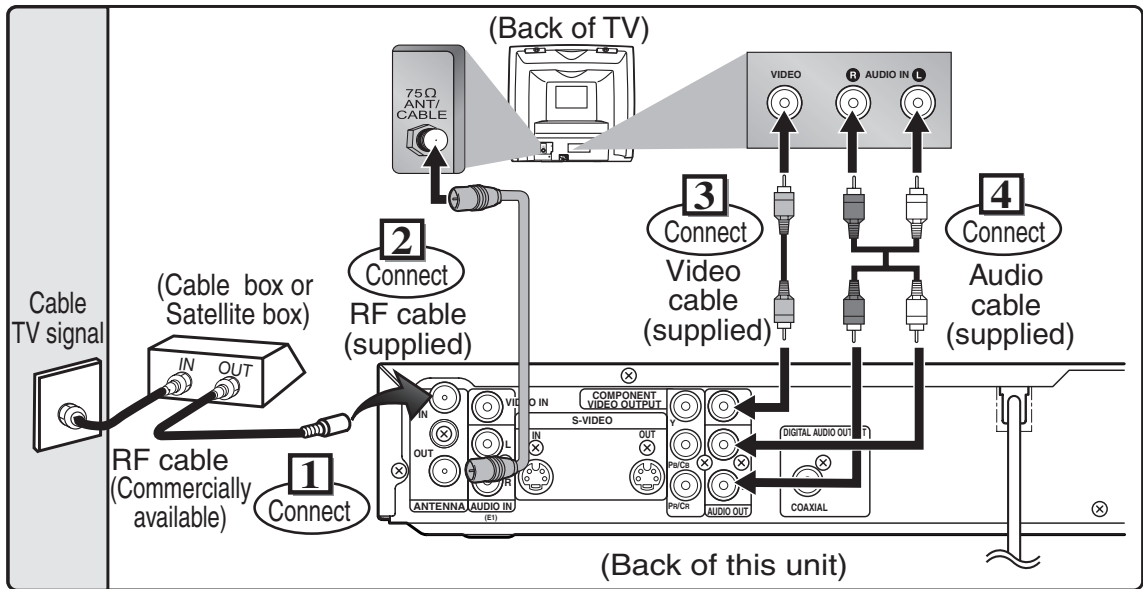

With this setup:

- You can record any unscrambled channel by selecting the channel on the cable box or satellite box. Be sure that the cable box or satellite box is turned on.
- **You cannot record one channel while watching another channel.**

### Note to the Cable TV System Installer :

This reminder is provided to call the Cable TV system installer's attention to Article 820-40 of the National Electrical Code, which provides guidelines for proper grounding - in particular, specifying that the cable ground shall be connected to the grounding system of the building, as close to the point of cable entry as possible.

# Connections

## Connection to an Audio System

- When you change the connections, all devices should be turned off.
- Refer to the operation manual accompanying external devices for more information.

### Method 1

#### Stereo system

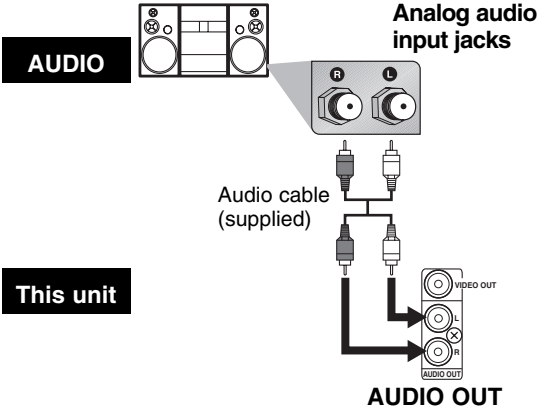

### Method 2

#### Dolby Digital decoder, MD deck or DAT deck

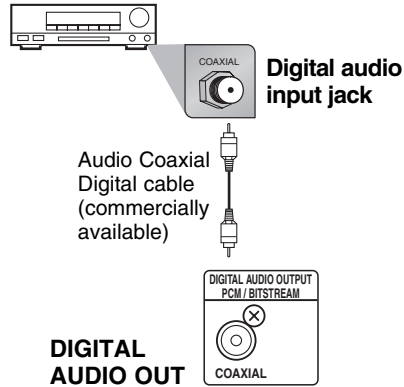

Connection	Setting	Setup > Playback > Disc Audio > Digital Out >
If output is Dolby Digital encoded audio, connect to a Dolby Digital decoder.		Dolby Digital Stream
Unless connected to a Dolby Digital decoder.		PCM
Connecting to an MD deck or DAT deck.		PCM

\* To complete these settings, refer to pages 66-67.

#### Note

- Playing a DVD using incorrect settings may generate noise distortion and may also damage the speakers.

#### Note

- The audio source on a disc in a Dolby Digital Multi-channel surround format cannot be recorded as digital sound by an MD or DAT deck.
- By hooking this unit up to a Multi-channel Dolby Digital decoder, you can enjoy high-quality Dolby Digital Multi-channel surround sound as heard in the movie theaters.
- Playing a DVD using incorrect settings may generate noise distortion and may also damage the speakers.

# Getting started

## Easy DVD recording

The following will help you to understand easily how to record to DVD discs.

### Note:

Make sure batteries are in the remote control and you have connected this unit with the TV correctly.

### Step 1: Choose a disc type.

There are several types of recordable DVD discs to choose from. This unit can record on the following type of discs.

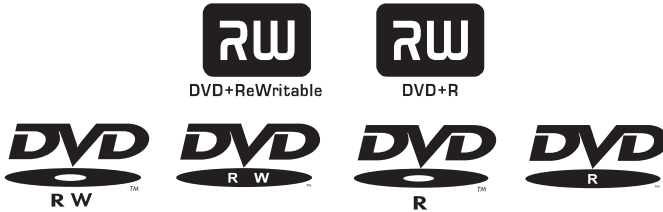

For example, when you want to record repeatedly on the same disc, select the rewritable DVD+RW/DVD-RW type disc. When you want to save recordings without any alteration, a non-rewritable DVD+R/DVD-R can be your choice.

### Step 2: Turn on the unit.

Remote Control

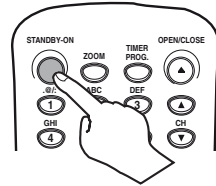

Select the input to which the unit is connected on your TV.

### Step 3: Insert a blank disc.

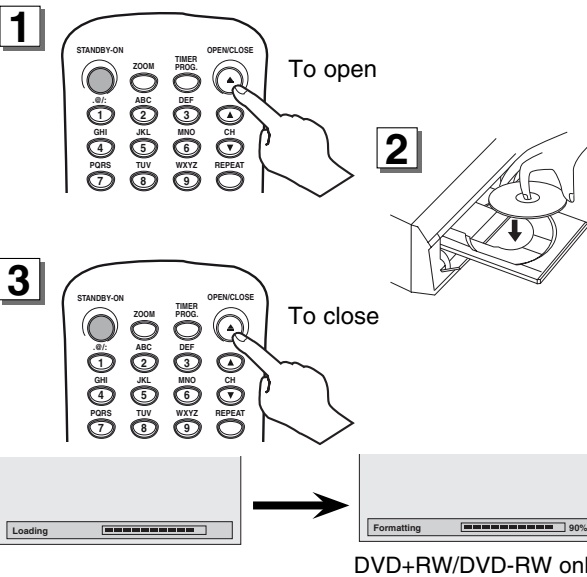

This operation may take a while to be recognized.

### Step 4: Select the recording mode.

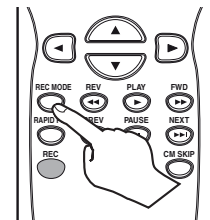



# Getting started

## Easy DVD recording (cont'd)

### Step 5: Select the desired channel.

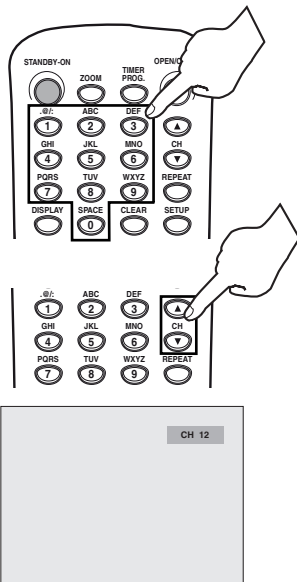

### Step 6: Record on DVD disc.

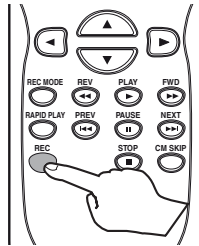

### Step 7: Stop the recording.

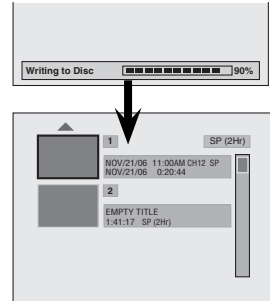
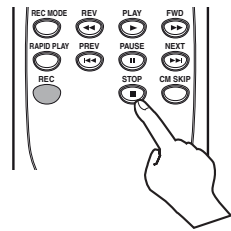

This operation may take a while to be completed.

### Hint 1: Play the recorded contents

You can select the title you want to play from a displayed title list, and immediately start to play. Recorded contents are easily accessible, with simple procedure of choosing a title on in the menu screen.

#### What are titles and chapters?

The contents of the DVD disc are generally divided into titles. Titles may be further divided into chapters.

### Hint 2: Edit the recorded disc

You will find editing discs is easy. This unit offers convenient edit functions to discs formatted with DVD+VR mode.

You can edit the following from a title list or setup menu.

- Deleting titles
- Putting names on titles
- Setting / clearing chapter marks
- Hiding chapters
- Setting pictures for thumbnails
- Dividing a title (DVD+RW/DVD-RW only)
- Putting name on disc

#### Finalizing a Disc

- This will allow DVD+R/DVD-RW/DVD-R discs recorded on this unit to be played back on a different DVD player — **without finalization it will not be playable on other units.**
- After finalizing a disc, you cannot edit contents on that disc.
- DVD+RW discs is not required to finalize but to "Make Edits Compatible" to play on other units after editing. You can edit the disc after "Make Edits Compatible".

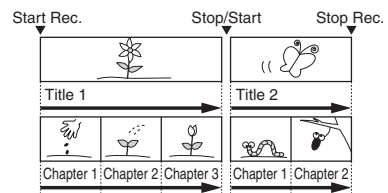

# Getting started

## Initial setting

Turn on this unit for the first time, you need to follow these steps.

**1**  
Press [STANDBY-ON].

**2**  
Turn the TV on. Select the input to which the unit is connected. Refer to the table on page 13.

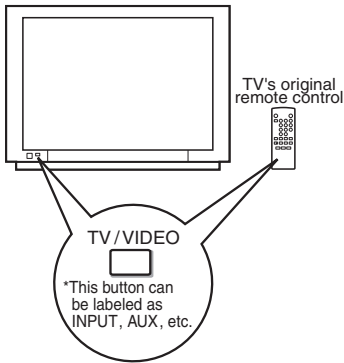

“Initial Setup” will automatically appear.

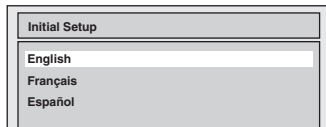

**3**  
Using [▲ / ▼], select your desired language on screen menu. Then press [OK] to set language. “Channel Preset” will automatically appear.

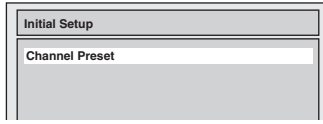

**4**  
Press [OK] to start Channel Preset. The unit will start getting channels available in your area.

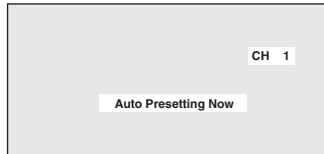

After channel setting is finished, “Clock Setting” will appear. Then press [OK].

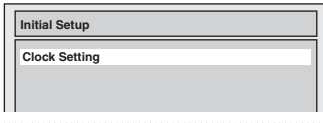

**5**  
Follow to step 3 in “Manual Clock Setting” on page 22.

- If a Public Broadcasting Station (PBS) is available in your area, follow “Auto Clock Setting” on page 21.

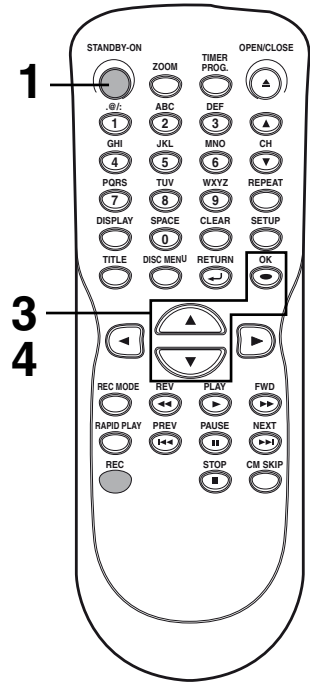

## Channel setting

If you have changed antenna connection, we recommend that you program available channels in your area with the following procedures.

### Getting channels automatically

**1**  
Press [SETUP].

**2**  
Using [▲ / ▼], select “Channel”. Press [OK]. Channel menu will appear.

**3**  
Using [▲ / ▼], select “Auto Channel Preset”. Press [OK]. The unit will start getting channels available in your area.

**4**  
Press [SETUP] to exit.

- You can select only the channels memorized in this unit by using [CH ▲ / ▼] or the Number buttons.

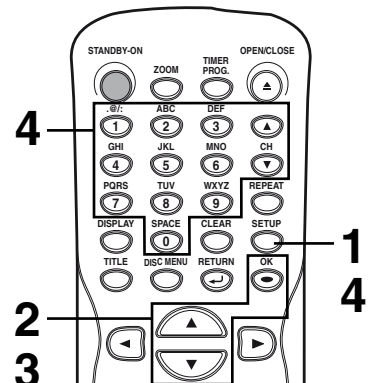

# Getting started

## Channel setting (cont'd)

### To select a channel

You can select a channel by directly entering channel using the **Number buttons** on the remote control.

#### Notes for using the Number buttons:

- When selecting cable channels which are higher than 99, enter channel numbers as a three-digit number. (For example: 117, press [1], [1], [7])
- You must precede single-digit channel numbers with a zero (For example: 02, 03, 04 and so on).
- You can select the line input mode ("E1" or "E2"). To select "E1" by pressing [0], [0], [1]. To select "E2" by pressing [0], [0], [2]. Details are on page 35.

### Note

- If the auto channel presetting is canceled during presetting, some channels not yet preset may not be received.
- The selection will depend on how you receive the TV channels.

#### To cancel the auto channel presetting during scanning:

Press [RETURN↵] or [SETUP] to cancel.

## Adding/deleting channels

The channels you no longer receive or seldom watch can be deleted from the memory. You also may add channels into memory.

### 1

Press [SETUP].

### 2

Using [▲ / ▼], select "Channel". Press [OK].

Channel menu will appear.

### 3

Using [▲ / ▼], select "Manual Channel Preset". Press [OK].

Manual Channel Preset menu will appear.

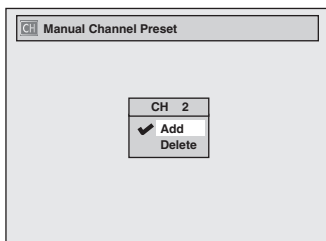

### 4

Select the channel number to add or delete.

Press [◀] or [CH ▼] to move to a lower channel number.

Press [▶] or [CH ▲] to move to a higher channel number.

Press the **Number buttons** to select a channel number directly.

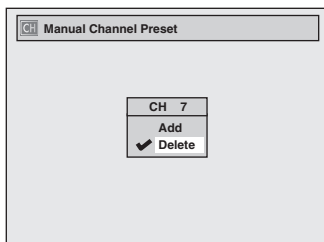

### 5

Using [▲ / ▼], select "Add" or "Delete". Press [OK].

The channel number will be added or deleted from the channel memory. Then the next channel number will appear so that you can continue adding or deleting channels.

### 6

Press [SETUP] to exit.

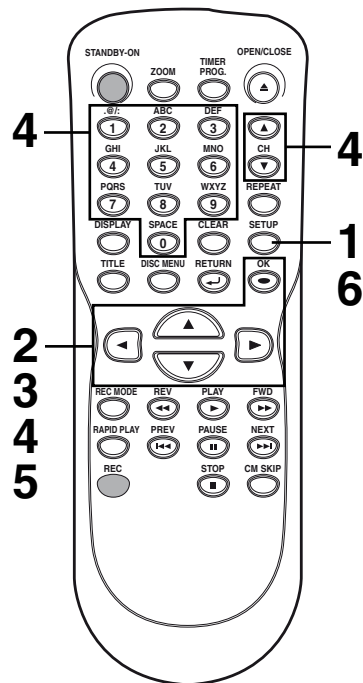

### Note

- [CH ▲ / ▼] works on the memorized channel in this unit.
- [◀ / ▶] works on all of channel numbers.

# Getting started

## Selecting the TV stereo or SAP

You can select a sound channel to output from TV. "Stereo" has been selected as the default.

**1**

Press [SETUP].

**2**

Using [▲ / ▼], select "Required Settings". Press [OK].  
Required Settings menu will appear.

**3**

Using [▲ / ▼], select "TV Audio Select". Press [OK].  
Option window will appear.

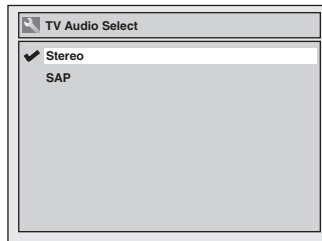

**4**

Using [▲ / ▼], select "Stereo" or "SAP". Press [OK].

**Stereo:**

Outputs main-audio.

**SAP (Secondary Audio Program):**

Outputs sub-audio.

**5**

Press [SETUP] to exit.

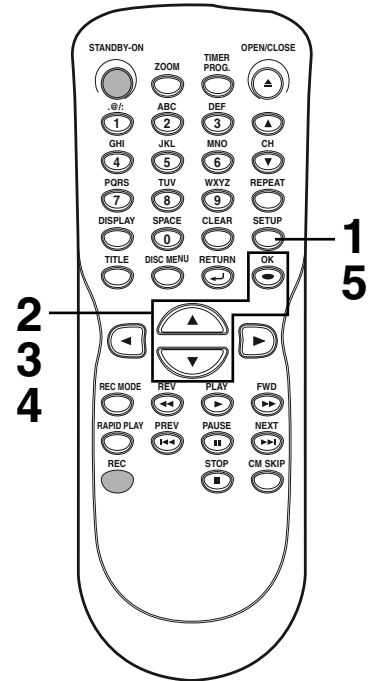

### Notes on TV channel audio

- When you record a TV program available in second audio or stereo, you have to select either Stereo or SAP in the Channel Preset screen beforehand. Refer to the following table to check an appropriate setting.

Selected audio	Broadcast audio	Disc recording	Audio output
Stereo	STEREO+SAP	STEREO	STEREO
	STEREO	STEREO	STEREO
	MONO+SAP	MONO	MONO
	MONO	MONO	MONO
SAP	STEREO+SAP	SAP	SAP
	STEREO	STEREO	STEREO
	MONO+SAP	SAP	SAP
	MONO	MONO	MONO

- You can only play the disc in second audio if a TV program is available in second audio and you set "TV Audio Select" to "SAP".

# Getting started

## Setting the clock

Set the clock before you try the Timer Programming. If a Public Broadcasting Station (PBS) is available in your area, follow "Auto Clock Setting" below. If not, follow "Manual Clock Setting" on page 22.

### Auto Clock Setting

Make sure

- The antenna/Cable TV connections are correct.
- If this unit is connected to a Cable Box or Satellite Box, select the local PBS station on them to set the clock automatically.

**1**  
Press [SETUP].

**2**  
Using [▲ / ▼], select "Clock". Press [OK].  
Clock menu will appear.

**3**  
Using [▲ / ▼], select "Auto Clock Setting". Press [OK].  
Option window will appear.

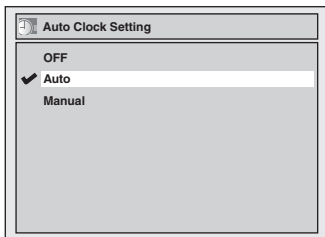

**4**  
• If you do not know your PBS channel number:  
Using [▲ / ▼], select "Auto". Press [OK].

The setting will be activated.

• If you know your PBS channel number:  
Using [▲ / ▼], select "Manual". Press [OK].

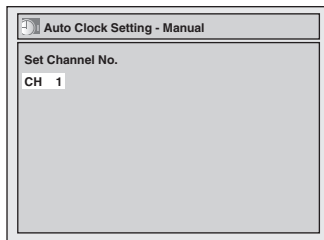

Using the Number buttons or [▲ / ▼], enter your PBS channel number. Press [OK].  
The setting will be activated.

• If you want to set the clock manually and cancel the Auto Clock Setting function: Using [▲ / ▼], select "OFF" in "Auto Clock Setting". Press [OK].  
The Auto Clock Setting function will be canceled.

**5**  
Press [SETUP] to exit.

**6**  
Press [STANDBY-ON] to turn off the unit.  
This unit will search for the time only when the power is off. Leave it off for several minutes to give this unit time to set the clock.

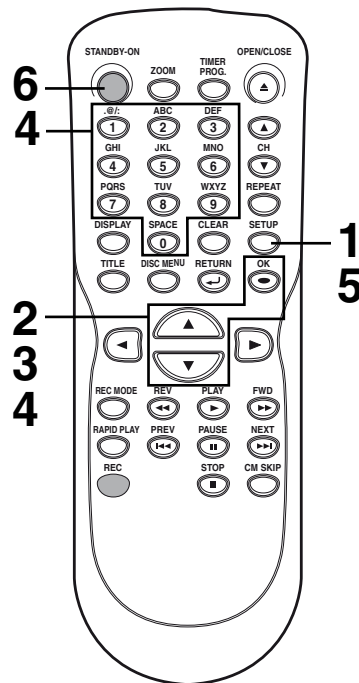

#### Note

- The clock may set itself automatically after you connect the antenna/cable signal to this unit and plug in the power cord.

# Getting started

## Setting the clock (cont'd)

### Manual Clock Setting

**1**

Press [SETUP].

**2**

Using [▲ / ▼], select "Clock".  
Press [OK].

**3**

Using [▲ / ▼], select "Clock Setting". Press [OK].  
Clock Setting menu will appear.

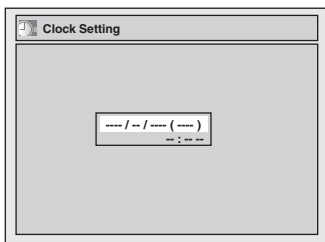

Press [OK] again.  
Default date will appear.

**4**

Using [▲ / ▼], enter the date  
(month / day / year).  
Press [◀ / ▶] to move the cursor.

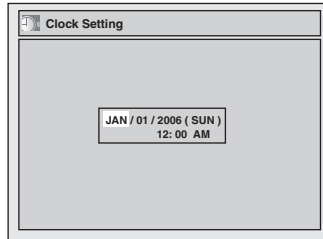

**5**

Using [▲ / ▼], enter the time  
(hour / minute). Press [◀ / ▶].  
A cursor will move to AM.

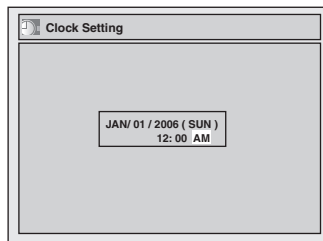

**6**

Press [▲ / ▼] to select "AM" or  
"PM". Press [OK].  
Clock menu will appear, then the  
settings will be activated.  
Although seconds are not dis-  
played, they begin counting from  
zero.

**7**

Press [SETUP] to exit, if Clock  
menu appears.

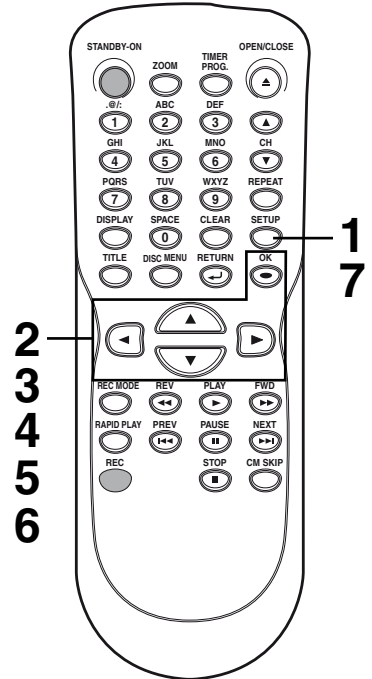

#### Note

- Your clock setting will be lost if either there is a power failure or this unit has been unplugged for more than 30 seconds when you set the clock manually.



# Getting started

## Setting the clock (cont'd)

### Setting the Daylight Saving Time

When “Daylight Saving Time” is ON, the unit clock will automatically move forward one hour on the first Sunday in April and move back one hour on the last Sunday in October.

“ON” has been selected as the default.

**1**  
Press [SETUP].

**2**  
Using [▲ / ▼], select “Clock”. Press [OK].  
Clock menu will appear.

**3**  
Using [▲ / ▼], select “Daylight Saving Time”. Press [OK].  
Option window will appear.

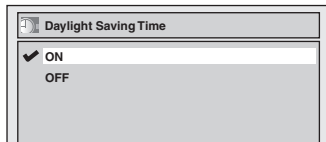

**4**  
Using [▲ / ▼], select “ON” or “OFF”. Press [OK].  
Select “ON” when currently utilizing the daylight saving time.

**5**  
Press [SETUP] to exit.

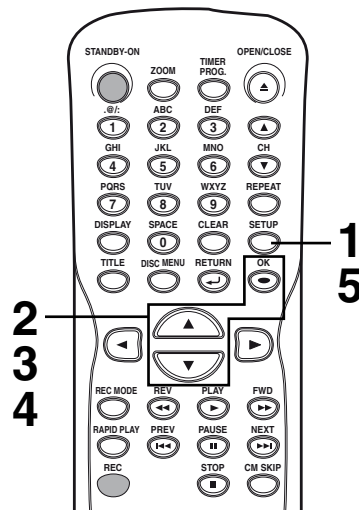

## Selecting the TV aspect ratio

You can select the TV aspect ratio to match the formats of what you are playing with the unit and your TV screen (4:3 standard or 16:9 widescreen TV).

“4:3 Letter Box” has been selected as the default.

**1**  
Press [SETUP].

**2**  
Using [▲ / ▼], select “Required Settings”. Press [OK].  
Required Settings menu will appear.

**3**  
Using [▲ / ▼], select “TV Aspect”. Press [OK].  
Option window will appear.

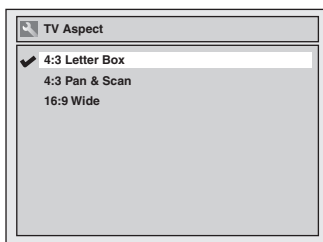

Refer to the Note on this page.

**4**  
Using [▲ / ▼], select a desired option. Press [OK].

**5**  
Press [SETUP] to exit.

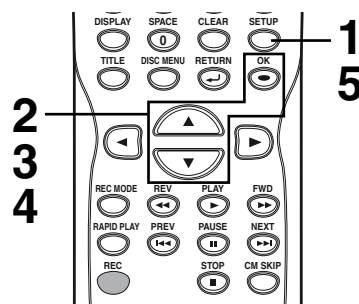

#### Note

##### If you have a standard TV:

Select “4:3 Letter Box”, so that black bars appear on the top and bottom of the screen when playing wide-screen picture and all that. Select “4:3 Pan & Scan” for a full height picture with both sides trimmed when playing wide-screen picture and all that.

##### If you have a widescreen TV:

Select “16:9 Wide”.

# Recording





## Information on DVD recording

### Information

This unit can record to DVD+RW, DVD-RW, DVD+R and DVD-R discs.

DVD+R/DVD-R discs can only be recorded to once. DVD+RW/DVD-RW discs can be recorded to and erased many times.

This unit will record DVD+VR mode automatically. DVD-RW/DVD-R disc will be recorded in the DVD+VR mode automatically in this unit.

Logo	Attributes
 DVD+ReWritable <b>DVD+RW</b>	8cm/12cm, single-sided, single layer disc Approx. max. recording time (SLP mode): 360 minutes (4.7GB) (for 12cm) 108 minutes (1.4GB) (for 8cm)
 DVD-R <b>DVD+R</b>	
 <b>DVD RW</b>	
 <b>DVD-RW</b>	8cm/12cm, single-sided, single layer disc Approx. max. recording time (SLP mode): 360 minutes (4.7GB) (for 12cm) 108 minutes (1.4GB) (for 8cm)
 <b>DVD R</b>	
 <b>DVD-R</b>	

### Recordable disc

- DVD+R 1x-16x, DVD+RW 1x-4x, DVD-R 8x/16x, and DVD-RW 4x discs can be used in this recorder.
- We strongly recommend for good recording quality: TDK DVD+R 4x/8x/16x, SONY DVD+R 4x/8x/16x, MAXELL DVD+R 4x/8x/16x, SONY DVD+RW 4x, MAXELL DVD-R 8x/16x, MAXELL DVD-RW 4x
- Discs that have been tested and are proven to be compatible with this recorder:  
 VERBATIM DVD+R 8x    VERBATIM DVD+RW 4x  
 VERBATIM DVD-R 8x    VERBATIM DVD-RW 2x  
 MAXELL DVD-R 16x    JVC DVD-RW 4x
- **You can play DVD+RW in most DVD players without finalizing. To play discs other than DVD+RW in other DVD players, you will need to finalize.**

### Recording mode

You can select a recording mode among 6 options, and the recording time will depend on the recording mode you select as follows.

Disc Size	Recording mode	Recording time	Video/Sound Quality
8cm Disc	HQ (1Hr)	18 min	☆☆☆☆☆☆ (good)
	SP (2Hr)	36 min	☆☆☆☆☆
	SPP (2.5Hr)	45 min	☆☆☆☆
	LP (3Hr)	54 min	☆☆☆
	EP (4Hr)	72 min	☆☆
	SLP (6Hr)	108 min	☆ (poor)
12cm Disc	HQ (1Hr)	60 min	☆☆☆☆☆☆ (good)
	SP (2Hr)	120 min	☆☆☆☆☆
	SPP (2.5Hr)	150 min	☆☆☆☆
	LP (3Hr)	180 min	☆☆☆
	EP (4Hr)	240 min	☆☆
	SLP (6Hr)	360 min	☆ (poor)

- The recording time are estimates and actual recording time may differ.
- The audio and video quality is getting poorer as the Recording time becomes longer.
- Each time **[REC MODE]** is pressed, recording mode and its allowed recording time will be displayed.

#### Note

- **This recorder cannot record CD-R or CD-RW discs.**
- DVD+RW/R, DVD-RW/R and CD-RW/R discs recorded on a personal computer or a DVD or CD recorder may not play if the disc is damaged or dirty or if there is dirt of condensation on the player's lens.
- If you record a disc using a personal computer, even if it is recorded in a compatible format, there are cases in which it may not play because of the settings of the application software used to create the disc. (Check with the software publisher for more detailed information.)
- DVD-RW/R discs recorded in Video mode cannot be recorded additionally using the unit.
- Since the recording is made by the variable bit rate (VBR) method, depending on the picture you are recording, the actual remaining time for recording may be a little shorter than the remaining time displayed on the OSD.
- You cannot record copy-protected video using this unit. (Copy-protected video includes DVD-Video discs and some satellite broadcasts.)
- You cannot record videos that includes "copy-once only" signal.

# Recording

## Information on DVD recording (cont'd)

### Making discs playable in other DVD player (Finalize/Make Edits Compatible)

After recording on DVD+R/DVD-RW/DVD-R, you must finalize the disc in order to play on other units. (Refer to page 36.)

There is no need to finalize DVD+RW discs but to "Make Edits Compatible" (refer to page 62) for playing on other units after editing.



**\*You cannot finalize or Make Edits Compatible in other DVD recorders.**

- Once DVD+R/DVD-RW/DVD-R discs are finalized, you cannot record additionally or edit.
- You cannot record additionally or edit on finalized DVD-RW discs unless the DVD-RW discs are performed "Undo Finalize".

# Recording

## Before recording

### Replacing disc menu



It can be used to prohibit recording additionally or to replace the title list after recording when inserting the disc includes titles and a different type of title list recorded by other units. "OFF" has been selected as the default.

Option window will appear.

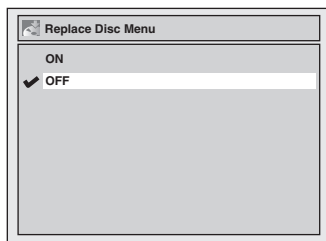

**1**  
Press [SETUP].

**2**  
Using [▲ / ▼], select "Recording". Press [OK].  
Recording menu will appear.

**3**  
Using [▲ / ▼], select "Replace Disc Menu". Press [OK].

**4**  
Using [▲ / ▼], select "ON" or "OFF". Press [OK].  
ON: Replacing the title list  
OFF: Prohibiting additional record

**5**  
Press [SETUP] to exit.

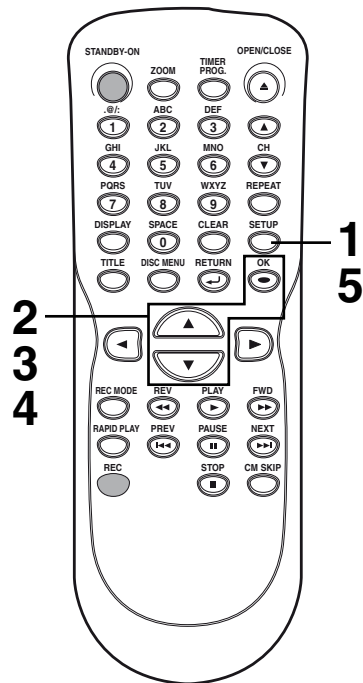

### Setting for Auto Chapter



You can set a specified time for chapter marks.

**1**  
Press [SETUP].

**2**  
Using [▲ / ▼], select "Recording".  
Press [OK].

**3**  
Using [▲ / ▼], select "Auto Chapter". Press [OK].  
Option window will appear.

**4**  
Using [▲ / ▼], select a desired time option. Press [OK].

**5**  
Press [SETUP] to exit.

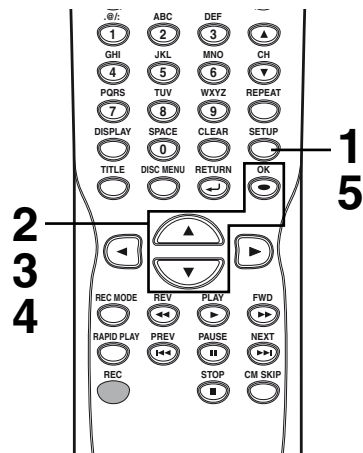
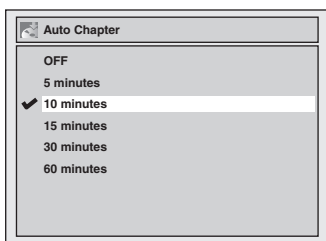

#### Note

- The interval for auto chapter marks may slightly deviate from the one you specified on the Auto chapter screen.
- A blank chapter may be created depending on the remaining time of the disc.

# Recording

## Basic recording



Follow the steps below to record TV programs.

**1**  
Press [STANDBY-ON].

Turn the TV on and be sure to select the input to which the unit is connected.

**2**  
Press [OPEN/CLOSE ▲].

The disc tray will open.

**3**  
Insert your disc with its label facing up. Align the disc to the disc tray guide.

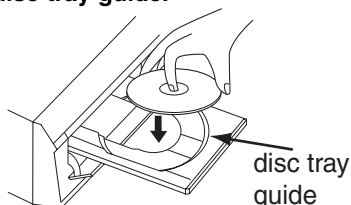

**4**  
Press [OPEN/CLOSE ▲] to close the disc tray.

**This operation may take a while to be completed.**

- When inserting a brand-new DVD+RW/DVD-RW disc, the unit automatically starts to format.
- If titles have been recorded on the disc, the title list is displayed. Press [STOP ■] to exit the title list.

**5**  
Using [REC MODE], select a recording mode.

Refer to "Recording mode" on page 24.

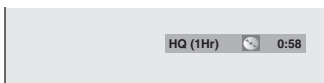

**6**  
Using [CH ▲ / ▼] or the Number buttons, select a desired channel to record.



**7**  
Press [REC] to start recording. "●" mark will be displayed for 5 seconds.

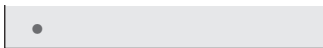

Press [PAUSE II] to pause recording. Press [PAUSE II] or [REC] again to restart recording.

**8**  
Press [STOP ■] to stop recording. The recorded title will be on the displayed title list. (Refer to "Guide to a title list" on page 51.)

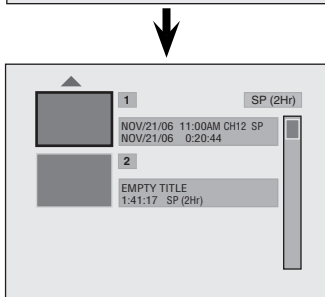

- Press [STOP ■] to exit the title list.

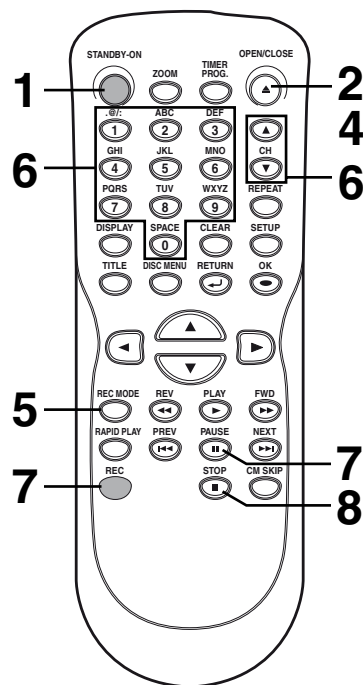

### Note

- Recording starts immediately and continues until the disc is full or you stop recording.
- When the unit clock has not been set, the space for a date and time of title names will be blank.
- When you record a TV program which has Stereo and SAP audio, you have to select the TV channel audio (Stereo or SAP) beforehand. Only the selected channel audio will be recorded. Refer to "Selecting the TV stereo or SAP" on page 20 for more details.
- You cannot change the recording mode during the REC pause mode.
- You can change a channel during the REC pause mode.

# Recording

## One-touch Timer Recording



This is a simple way to set the recording time in blocks of 30 minutes. Check that the disc you are recording onto has enough space for the time you set. When the recording finishes the recorder automatically goes into standby mode.

**1**

**Turn on the unit and load a recordable disc.**

Make sure that the TV input is set on the unit.

**This operation may take a while to be recognized.**

**2**

**Using [REC MODE], select a recording mode.**

Refer to "Recording mode" on page 24.

**3**

**Using [CH ▲ / ▼] or the Number buttons, select a desired channel to record.**

**4**

**Press [REC] repeatedly to select desired recording time.**

Recording times appear on the TV screen (30 minutes to 6 hours).

Recording will start.

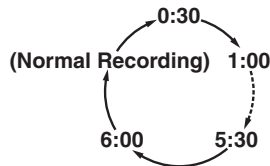
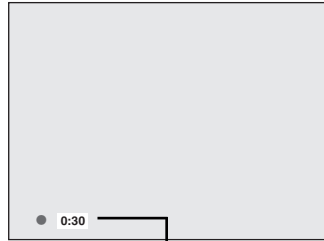

When the unit reaches the specified time, it will be turned off automatically.

To change the recording length during the One-touch Timer Recording, press [REC] repeatedly until the desired length appear.

To cancel the One-touch Timer Recording within the specified time, press [STOP ■].

**This operation may take a while to be completed.**

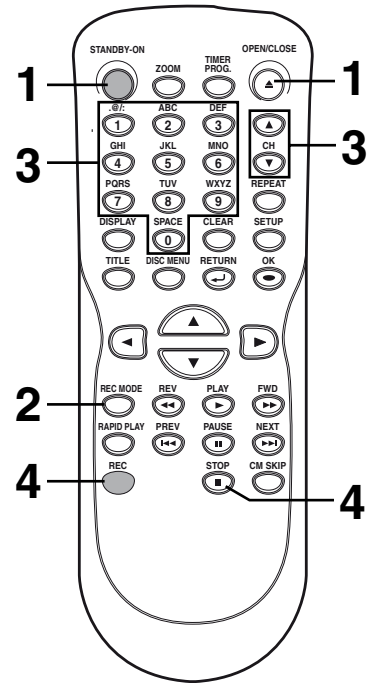

### Note

- Press [DISPLAY] to see the remaining recording time on the TV screen during the One-touch Timer Recording.
- You cannot pause the One-touch Timer Recording.
- Unlike a Timer Recording, you can perform the following operations during the One-touch Timer Recording.
  - Turning the power off.
  - Using [REC] and [STOP ■].
- The unit will be turned off automatically under the following conditions.
  - 1) No space remained on the disc.
  - 2) When a power failure occurs.



# Recording

## Timer Recording



You can program the unit to record up to 8 programs within a month in advance. Daily or weekly program recordings are also available.

- Be sure to set the clock before setting a timer programming.
- Insert a recordable disc.

**1**

Press [TIMER PROG.].

Timer Programming list will appear.

Date	Start	End	CH	Mode
1. ---				
2. ---				
3. ---				

**2**

Using [▲ / ▼], select a program number. Press [OK].

**3**

Using [▲ / ▼], enter the Date. Press [▶].

Date	Start	End	CH	Mode
1. JAN/01	12:57AM	1:57AM	CH 8	E1
2. ---				
3. ---				

When pressing [▼] at the current date, the Date will change as follows.

e.g. January 1st

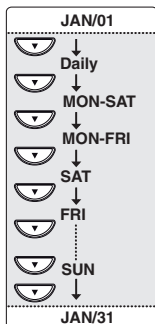

**4**

Using [▲ / ▼], enter the Start and End time. Press [▶].

Date	Start	End	CH	Mode
1. JAN/01	12:57AM	--:--	E1	
2. ---				
3. ---				

**5**

Using [▲ / ▼], select the CH number to record. Press [▶].

Date	Start	End	CH	Mode
1. JAN/01	12:57AM	1:57AM	CH 8	
2. ---				
3. ---				

To record from external input, select E1 or E2.

**6**

Using [▲ / ▼], select a recording mode.

Date	Start	End	CH	Mode
1. JAN/01	12:57AM	1:57AM	CH 8	HQ
2. ---				
3. ---				

Refer to "Recording mode" on page 24.

When "Auto" is selected as a recording mode, the unit determines how much time is available on the disc and record in the appropriate recording mode to complete recording the program.

Date	Start	End	CH	Mode
1. JAN/01	12:57AM	1:57AM	CH 8	Auto
2. ---				
3. ---				

**7**

Press [OK] when all items are entered.

Your program setting will be stored.

- To set another program, repeat steps 2 to 7.
- To exit, press [TIMER PROG.] or [SETUP].
- When two or more programs are overlapped, "Overlap" and the overlapped program number will appear.

**8**

Press [STANDBY-ON] to set a Timer Programming. TIMER REC indicator will light up on the front panel.

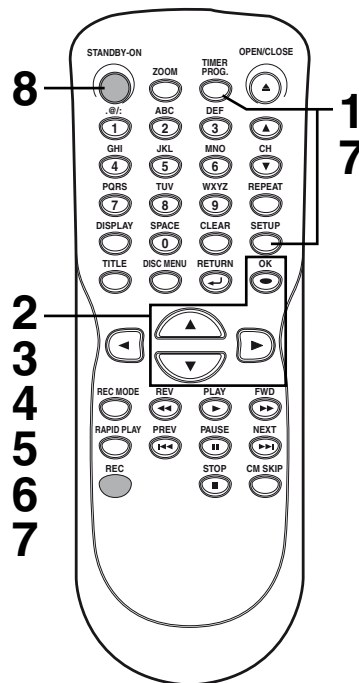

### Note

- **If you have not set the clock yet:**

A manual clock setting menu will appear instead of the Timer Programming list at step 1. Continue with the step 3 in "Manual Clock Setting" on page 22 before setting a timer programming.

- Press [◀ / ▶] to move the cursor to the left and the right in the timer programming menu.
- After step 8, the recording will start immediately after the recording time you set.

# Recording

## Timer Recording (cont'd)

### Checking, canceling, or correcting the timer programming information

**1**  
Press [STANDBY-ON].  
TIMER REC indicator will be off on the front panel.

**2**  
Press [TIMER PROG.].

Timer Programming				
Date	Start	End	CH	Mode
1. JAN/01	12:57AM	1:57AM	CH 8	HQ
2. ---				

Timer Programming list will appear.

**3**  
Check the information on the list you will need.

**4**  
To clear the timer programming:  
Using [▲ / ▼], select the program. Press [CLEAR].

To correct the timer programming:  
Using [▲ / ▼], select your desired program. Press [OK].  
Next, correct the timer programming by using [▲ / ▼ / ◀ / ▶]. Finally, press [OK] again.

**5**  
Press [TIMER PROG.] to exit.

**6**  
Press [STANDBY-ON] to return to the timer standby mode.

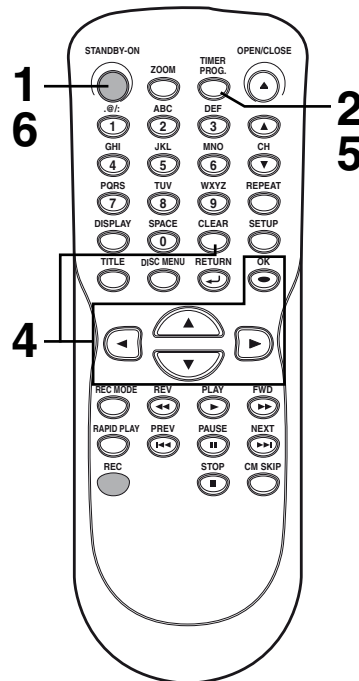

### Note

- Press [TIMER PROG.] to check the timer programming in process.
- When the Timer Recording is proceeding, that program will be highlighted with red. In this case, you cannot select any other program.

### To stop the Timer Recording in process

Press [STOP ■] on the front panel of the unit.  
[STOP ■] on the remote control is not effective.

If the timer program did not complete correctly, the error number appears in the Timer Programming list.

Timer Programming				
Date	Start	End	CH	Mode
* JAN/01	12:57AM	1:57AM	CH 8	E22
2. ---				
3. ---				
4. ---				
5. ---				
6. ---				
7. ---				
8. ---				

Press [CLEAR] to erase the selected program.

### Each error number means:

E1-22 E37-39	Recording error other than below	E41	Power failed
E24	Unrecordable disc	E42	No disc when recording
E25-26	Copy prohibited program	E43	Already 49 titles recorded
E29	Disc protected	E44	Already 254 chapters recorded
E30	Disc full	E45	Copy prohibited program
E35	PCA full	E46	It is impossible to record additionally on a disc recorded by other units when setting Replace Disc Menu to OFF.
E36	Already finalized Video format disc		
E40	Some portion has not been recorded because of program overlapping. Recording did not start at the start time.		

- E23, E27, E28, E31, E32, E33 and E34 are not displayed.

- A program with the error number is grayed and asterisked in the Timer Programming list.
- Once the Timer Programming list with error line(s) is displayed, or after canceling and setting again the timer standby mode, the program line(s) with error will be cleared.

# Recording

## Timer Recording (cont'd)

### Hints for Timer Recording

- If there is a power failure or this unit has been unplugged for more than 30 seconds, the clock setting and all timer programming will be lost.
- If a disc is not on the tray, TIMER REC indicator flashes and Timer Recording cannot be performed. In some cases, TIMER REC indicator will light up momentarily around the start point as the unit attempts to record. Please insert a recordable disc.
- When all the Timer Recording is completed, TIMER REC indicator flashes. To play or eject the recorded disc, press **[STANDBY-ON]** first, then select the recorded title and press **[PLAY ►]** or **[OPEN/CLOSE ▲]**.
- During Timer Recording or timer standby mode (TIMER REC indicator will light up), any operations on the unit will not be available. To make these operations available, cancel the Timer Recording or timer standby mode first (TIMER REC indicator will be off).
- To cancel the timer standby mode, press **[STANDBY-ON]**.
- When the Start and the End time are the same, the length of the recording will be set for 24 hours. When the disc reaches at the end during the recording, the unit turns itself off.
- When the programmed Start and End time are earlier than the current time, the setting will not be accepted and be cleared for redoing.
- If the Start time is earlier and the End time is later than the current time, the recording will start right after you turn the power off.

### The priority of overlapped settings

This unit records the programs according to priority if the timer programmings are overlapped. The timer programming set previously has priority.

A Timer Recording of lower priority will be canceled, start from the middle or stop on the way. Check the overlapped timer programmings and change the priority if necessary.

**A programming set previously has priority**

- When the starting time is the same:**  
A program set previously (PROG. A) has priority.

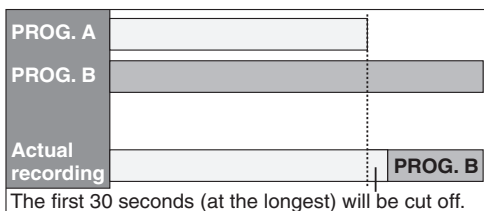

**When some programming have been made at the end time of the programming currently being recorded:**

A program set previously (PROG. B) has priority.

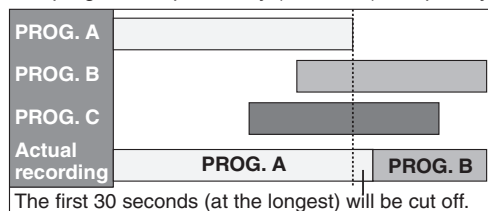

**When the recording time is partially overlapped:**

PROG. A will start after PROG. B is complete to be recorded.

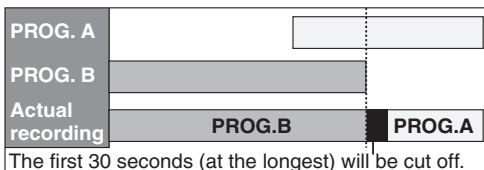

**When the recording time is entirely overlapped:**

PROG.A will not be recorded.

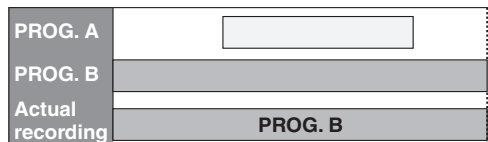

### Note for DVD recording

- When the recording time of two programs are overlapped, or the End time of a program and the Start time of another program is the same, the first 30 seconds (at the longest) of the subsequent program will be cut off.
- If the cut-off portion comes up to one minute or more, this program will be displayed with error number E40 in the timer programming list.

- When the End time of the programming currently being recorded and the Start time of the subsequent program are same:**  
If PROG. A is a DVD recording program, the beginning of the PROG. B may be cut off.

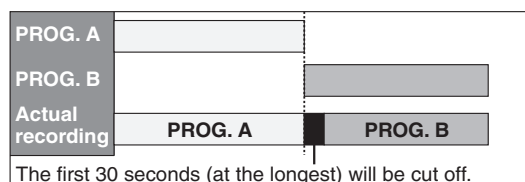

# Recording

## Overwriting an existing title

### Overwriting from the beginning of the title



You can overwrite the existing title from the beginning.

**1**  
Press [STANDBY-ON].

Make sure that the TV input is set on the unit.

**2**  
Load the disc that includes a title to be overwritten.

Title list will appear.

If the title list does not appear, press [DISC MENU].

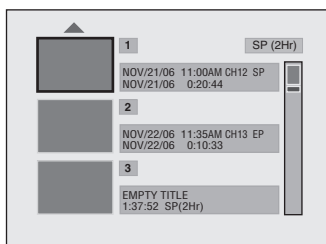

This operation may take a while to be recognized.

**3**  
Using [REC MODE], select a recording mode.

Refer to "Recording mode" on page 24.

**4**  
Using [▲ / ▼], select a title to be overwritten. Press [OK].

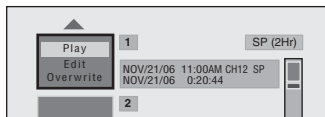

**5**  
Using [▲ / ▼], select "Overwrite". Press [OK].  
Channel can be changed.

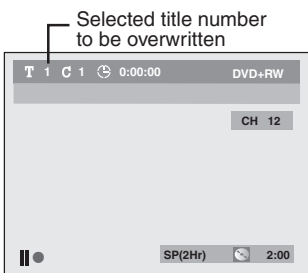

**6**  
Press [REC].  
Overwriting recording starts.  
The elapsed-time counter starts running.

**7**  
Press [STOP ■] to stop recording.  
Title name is also overwritten.

This operation may take a while to be recognized.

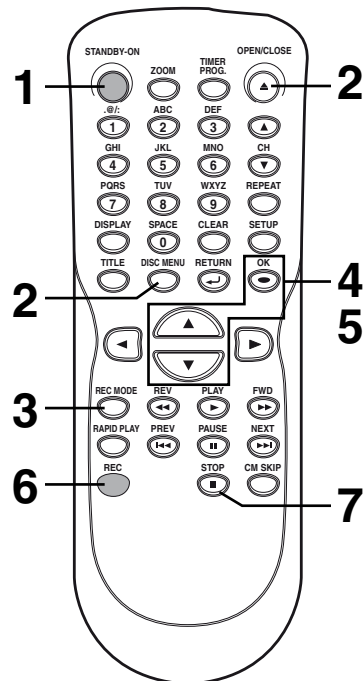

#### Note

- Remaining time, which is displayed on the bottom right corner of the screen during overwriting, indicates the remaining time at the time of starting overwriting.

### Overwriting in the middle of the title



You can overwrite the existing title from the selected position.

**1**  
Proceed to steps 1 to 2 above.

**2**  
Using [▲ / ▼], select a title to be overwritten. Press [OK].

**3**  
Using [▲ / ▼], select "Play".  
Press [OK].  
Playback will start.

**4**  
Press [PAUSE II] at the point from which you want to start overwriting.

**5**  
Press [REC].  
"II" mark, Display menu, CH, and the time lapse will be displayed as stated above.

Channel can be changed.

**6**  
Press [REC] again.  
Overwriting recording starts.

**7**  
Press [STOP ■] to stop recording.  
Title name is not overwritten.

This operation may take a while to be recognized.

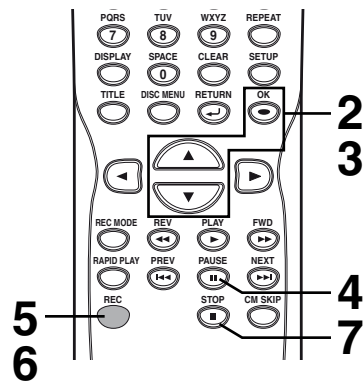

#### Note

- Recording mode of the overwriting title is the same as that of the original (overwritten) title when overwriting in the middle of the title.

## Overwriting an existing title (cont'd)

### Hints for Overwriting

When an existing title is overwritten, the title name may be changed according to the overwriting situations. Before overwriting, read the following cases and Note.

- When overwriting title is shorter than the existing title:**  
(Overwriting from the beginning of the title)

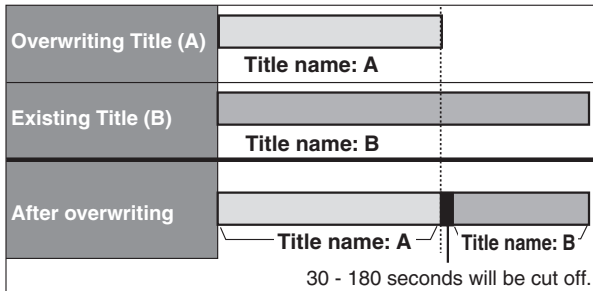

- When overwriting title is longer than the existing title:**  
(Overwriting from the beginning of the title)

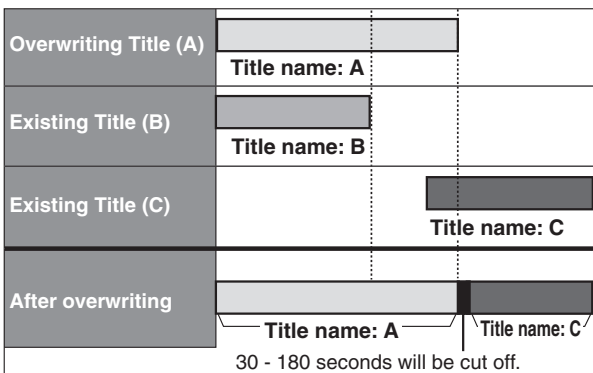
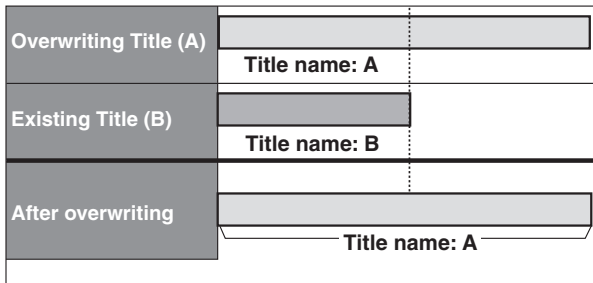

- When overwriting in the middle of the title:**

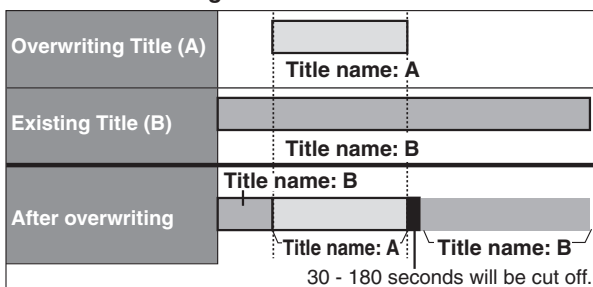

#### Note

- When a title name is overwritten, its thumbnail is also overwritten.
- When existing title is longer than the overwriting title, overwriting title is divided into 2 titles. If this is the case, there may be an unrecorded portion between titles.
- A chapter mark is put between titles when overwriting in the middle of the title.
- "Auto Chapter" interval time is reset at the overwriting start point.

# Recording

## Settings for an external source

### Connection to an external source



Connect the external source properly to the unit by using input jacks either EXT2 (Front) or EXT1 (Rear). When connecting an external equipment of monaural output to this unit, use AUDIO L jack of EXT2 (Front). Use commercially available S-Video or Video cable and an Audio cable for this connection.

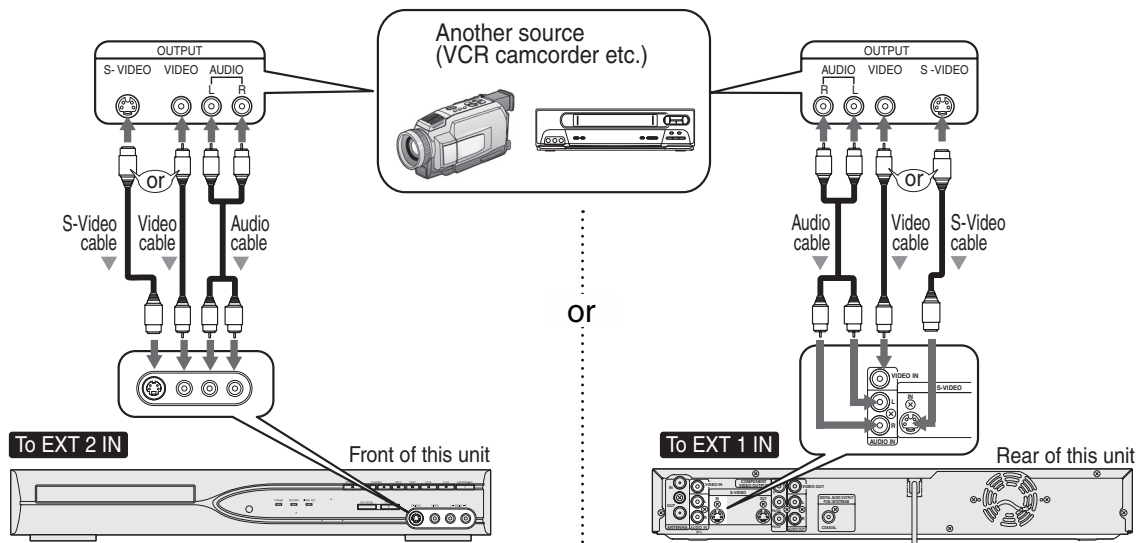

1. Press [SETUP].
2. Using [▲ / ▼], select “Required Settings”. Press [OK].
3. Using [▲ / ▼], select “Video Input”. Press [OK].

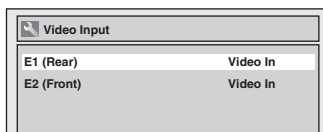

4. Using [▲ / ▼], select “E2 (Front)”. Press [OK].

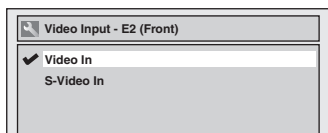

5. Using [▲ / ▼], select the input jack type to connect. Press [OK].

If you want to use VIDEO input (Composite) jack, select “Video In”.

If you want to use S-VIDEO input jack, select “S-Video In”.

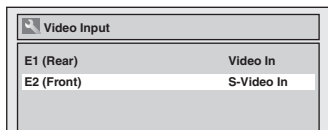

6. Press [SETUP] to exit.

4. Using [▲ / ▼], select “E1 (Rear)”. Press [OK].

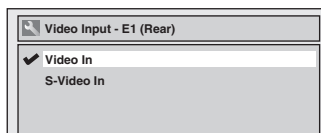

5. Using [▲ / ▼], select the input jack type to connect. Press [OK].

If you want to use VIDEO IN (Composite) jack, select “Video In”.

If you want to use S-VIDEO IN jack, select “S-Video In”.

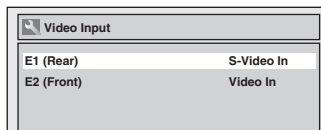

6. Press [SETUP] to exit.

# Recording

## Settings for an external source (cont'd)

### Recording from an external source



Before recording from an external source, see the instructions for the connection on page 34.

1. Turn the TV and this unit on, and be sure to select the input of the TV to which the unit is connected.

Refer to the table on page 13.

2. Press [OPEN/CLOSE ▲] to open the disc tray. Place the disc to record properly.

3. Press [OPEN/CLOSE ▲] to close the disc tray.

**This operation may take a while to be recognized.**

4. Select the input of the unit which the external equipment is connected. (E2 or E1)

- To use the input jacks on the back of this unit, select "E1 (Rear)" position by pressing [0], [0], [1] with the Number buttons on the remote control.
- To use the input jacks on the front of this unit, select "E2 (Front)" position by pressing [0], [0], [2] with the Number buttons on the remote control.

5. Select a recording mode by pressing [REC MODE].

Refer to "Recording mode" on page 24.

6. Press [RECORD] on the unit to start recording.

7. Press "Play" on the external source to record from.

8. Press [STOP ■] on the unit to stop recording.

**This operation may take a while to be completed.**

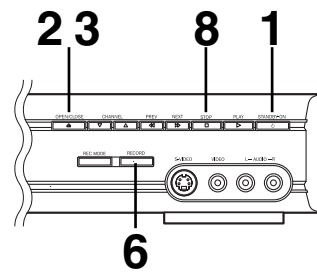
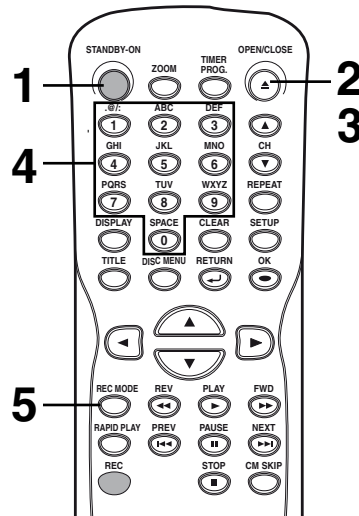
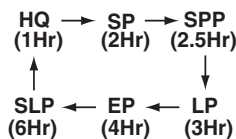

### Setting a disc to protect



To prevent accidental recording, editing or erasing the titles, you can protect them from the Setting menu.

1 Press [SETUP].

2 Using [▲ / ▼], select "Disc Edit". Press [OK].  
Disc menu will appear.

3 Using [▲ / ▼], select "Disc Protect OFF → ON". Press [OK].

Confirmation window will appear.

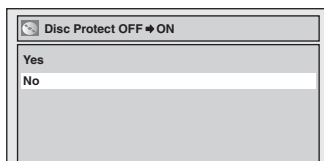

4 Using [▲ / ▼], select "Yes". Press [OK].  
A disc will be protected.

**This operation may take a while to be completed.**

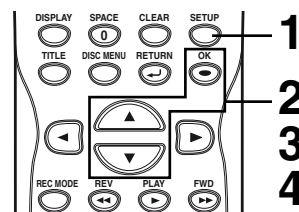

#### Note

**To cancel the disc protect:**

- When you insert a disc protected with this unit, "Disc Protect ON → OFF" will appear instead of "OFF → ON".

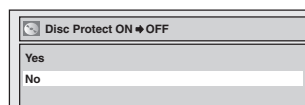

To release the protect for the disc, select "Disc Protect ON → OFF" at step 3, then select "Yes".



# Recording

## Playing the discs in other DVD players

### Finalizing a disc



You will need to finalize discs to play in other DVD players. Finalizing may take several minutes up to an hour. A shorter recording period on the disc will require a longer time period for finalization. Do not unplug the power cord during finalization. Details are on page 25.

**1**

Press [SETUP].

**2**

Using [▲ / ▼], select “Disc Edit”. Press [OK].  
Disc menu will appear.

**3**

Using [▲ / ▼], select “Finalize”. Press [OK].  
Confirmation window will appear.

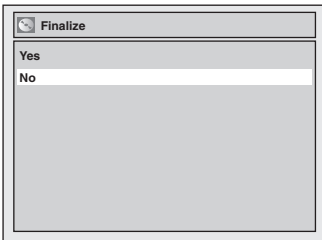

**4**

Using [▲ / ▼], select “Yes”. Press [OK].  
Finalizing will start.



#### To cancel finalizing...

(DVD-RW only)

- To cancel finalizing at step 4, press [STOP ■], select “Yes” with [◀ / ▶], then press [OK]. Finalizing is canceled and the unit will be in stop mode.

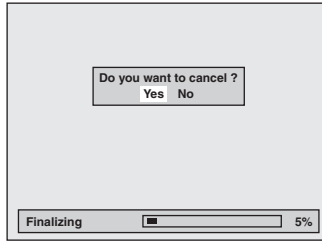

- If ⓪ appears when pressing [STOP ■], you cannot cancel finalizing because the finalizing has been in certain progress.
- When selecting “No” and press [OK] or [RETURN↵], finalizing will be continued.
- You cannot cancel finalizing the DVD+R/DVD-R disc once it has started.

**This operation may take a while to be completed.**

**5**

Finalizing is completed.

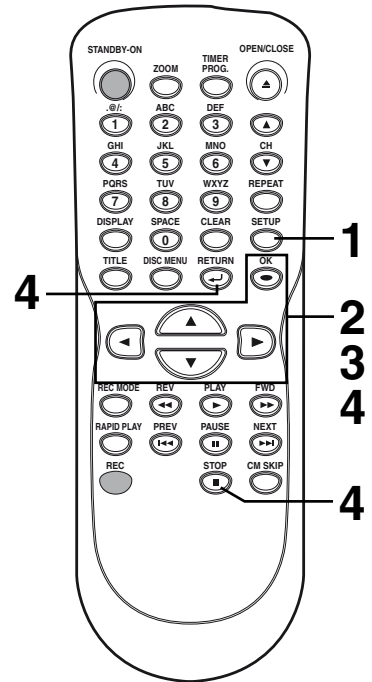
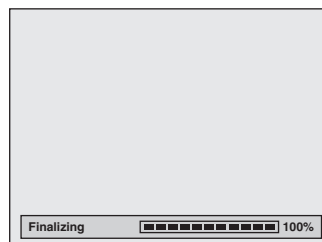

#### Note

- Once you have finalized a disc recorded on DVD+R/ DVD-R, you cannot edit or record anything on that disc.
- There is no need to finalize DVD+RW discs.**
- When you insert a DVD-RW disc finalized with this unit, “Undo Finalize” will appear instead of “Finalize”.

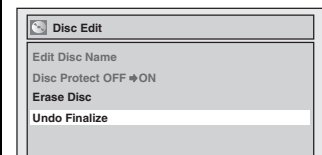

To release the finalizing for the disc, select “Undo Finalize” at step 3.

- \* DO NOT power off during finalization, this will result in malfunction.

# Recording

## Playing the discs in other DVD players (cont'd)

### Auto finalizing



You can finalize discs automatically using Auto Finalize function. You can use this function to finalize discs after finishing all Timer Recordings and at the end of the disc space.

**1**

Press [SETUP].

**2**

Using [▲ / ▼], select "Recording". Press [OK].  
Recording menu will appear.

**3**

Using [▲ / ▼], select "Auto Finalize". Press [OK].  
Auto Finalize menu will appear.

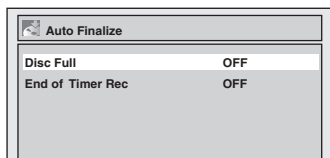

**4**

Using [▲ / ▼], select "Disc Full" or "End of Timer Rec". Press [OK].

Option window will appear.

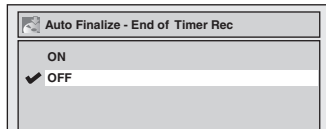
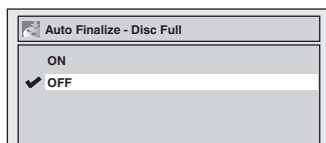

**5**

Using [▲ / ▼], select "ON". Press [OK].

Your setting will be activated.

**6**

Press [SETUP] to exit.

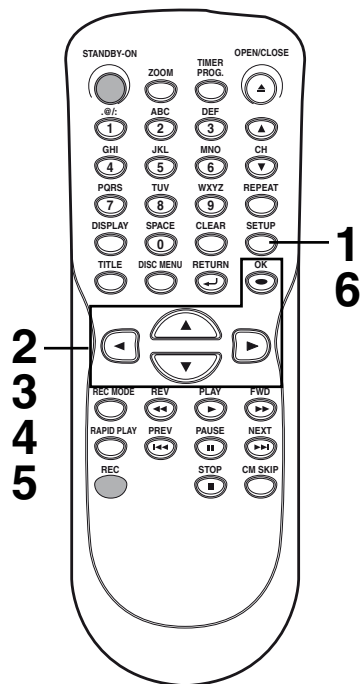

# Playing discs

## Information on DVD play

Before you play DVD discs, read the following information.

### Playable discs

This unit is compatible to play the following discs. To play a DVD, make sure that it meets the requirements for Region Codes and Color Systems as described below. Discs that have the following logos will play on the unit. Other disc types are not guaranteed to play.

Disc	Logo
DVD-VIDEO	
DVD+RW	
DVD+R	
DVD+R Double Layer	
DVD-RW (VIDEO mode, Finalized)	
DVD-R (VIDEO mode, Finalized)	
CD-DA (AUDIO CD)	
Video CD	
CD-RW (CD-DA FORMAT, MP3 files)	
CD-R (CD-DA FORMAT, MP3 files)	

**DVD** is a trademark of DVD Format/Logo Licensing Corporation.

### Color systems

DVDs are recorded in different color systems throughout the world. The most common color system is NTSC (which is used primarily in the United States and Canada). This unit uses NTSC, so DVDs you play must be recorded

in the NTSC system. You cannot play DVDs recorded in other color system .

### Region codes

This unit has been designed to play DVD discs with Region One (1). DVDs must be labeled for ALL regions or for Region 1 in order to play on the unit. You cannot play DVDs that are labeled for other regions. Look for the symbols on the right on your DVDs. If these region symbols do not appear on your DVD, you cannot play the DVD in this unit.



The number inside the globe refers to region of the world. A DVD labeled for a specific region can only play on the unit with the same region code.

### PBC (Playback Control) for Video CD

This unit conforms to ver. 1.1 and ver. 2.0 of Video CD standard with PBC function.

Ver. 1.1 (without PBC function): You can enjoy playback picture as well as music CD.

Ver. 2.0 (with PBC function): While using a Video CD with PBC function, "PBC" appears on the screen.

NOTE: When playing Video CDs with PBC function, some operations (e.g., track search and repeat tracks) cannot be performed. Cancel PBC function temporarily to perform those operations (refer to page 70).

You can play interactive software using menu screens. Refer to instructions in the Video CD.

### Hint for DVD playback

The contents of DVD disc are generally divided into titles. Titles may be further subdivided into chapters.

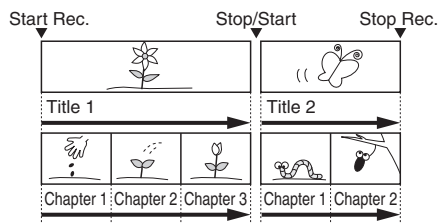

## Guide to displays

Press **[DISPLAY]** to call up the Display menu. This menu will give you the information on the playing disc. Some operations are available while disc is playing.

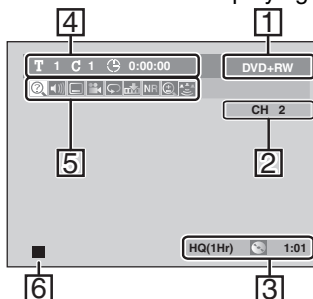

1. Indicates a disc type and a format mode. (Format mode is displayed with DVD-RW/DVD-R (Video mode) discs inserted.)  
**NOTE:** In some descriptions on this manual, only one disc type is indicated as an example.
2. Indicates a channel number.
3. Indicates a recording mode and possible recording time left.
4. Indicates a title number, chapter number and the time lapse of disc play.

5. Each icon means:

- : Search
- : Audio
- : Subtitle
- : Angle
- : Repeat
- : Marker
- : Noise Reduction
- : Zoom
- : Surround

6. Indicates current disc status.

# Playing discs

## Basic playback

### Playback



1

Press [STANDBY-ON].

Turn the TV on and be sure to select the input to which the unit is connected.

2

Press [OPEN/CLOSE ▲].

The disc tray will open.

3

Insert your disc with its label facing up. Align the disc to the disc tray guide.

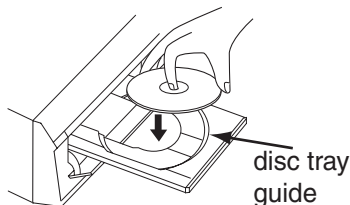

4

Press [OPEN/CLOSE ▲] to close the disc tray.

**This operation may take a while to be recognized.**

Title list will appear automatically.

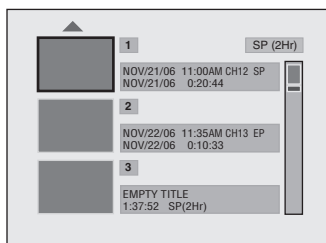

If you want to return to the playback while you are stopping temporarily, press [TITLE] to resume play.

To exit the title list, press [STOP ■].

5

Using [▲ / ▼], select a desired title. Press [OK].

Pop-up window will appear.



If you want to see Disc information, press [◀] when the first page of the title list is displayed or press [▲] when the first title is selected but "Play", "Edit" or "Overwrite" is not highlighted.

When inserting <DVD+RW> disc.



When inserting <DVD+R/DVD-RW/DVD-R> disc.

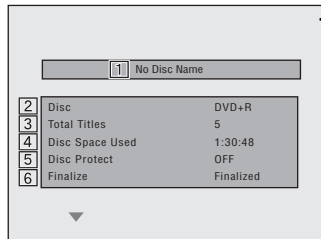

6

Using [▲ / ▼], select "Play".

Press [OK].

Playback will start.

7

Press [STOP ■] to stop playback.

To eject the disc, press [OPEN/CLOSE ▲] to open the disc tray, then remove the disc before turning the unit off.

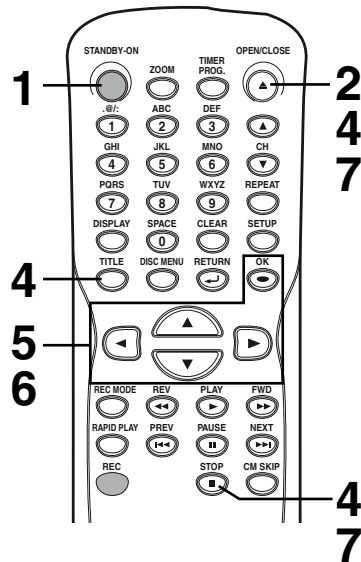

1. Disc name (Default "No Disc Name")
2. Disc Type (DVD+RW/DVD+R/DVD-RW/DVD-R)
3. Total number of title (include "Empty Title")
4. Total time of recorded disc space
5. Status of disc protection ("ON" is protected disc.)
6. Making edits compatible/ Finalize
  - When DVD+RW disc is inserted: If edit for which "Make Edits Compatible" is necessary is done, "Needed" is displayed. "Not Needed" is not necessary.
  - When DVD+R, DVD-RW or DVD-R disc is inserted: If "Finalize" is done, "Finalized" is displayed. Otherwise, "Unfinalized" is displayed.

#### Note

- Some discs may start playback automatically.
- You can also start playback by pressing [PLAY ▶] instead of [OK] at step 5.
- Press [▶] to display the next page, and press [◀] to display the previous page.

# Playing discs

## Basic playback (cont'd)



**1**  
Press [STANDBY-ON].  
Turn the TV on and be sure to select the input to which the unit is connected.

**2**  
Press [OPEN/CLOSE ▲] to open the disc tray.  
The disc tray will open.

**3**  
Insert your disc with its label facing up. Align the disc to the disc tray guide.

**4**  
Press [PLAY ►] to start playback.  
Playback will start.

If you are playing a DVD-Video disc or Video CD with PBC function, a menu may appear. Refer to page 41 for details about a disc menu.  
If you are playing a finalized DVD-R/DVD-RW disc, a title list will appear.

**5**  
Press [STOP ■] to stop playback.

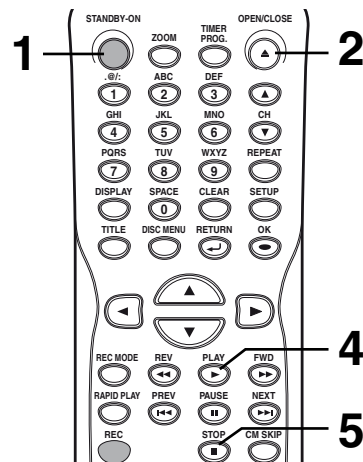

### Note

- Some discs may start playback automatically.
- You can select images or information on the menu screen by activating PBC (Playback control) function (page 70).

## Playing MP3 disc



**1**  
In stop mode, press [TITLE] to call up the MP3 menu.

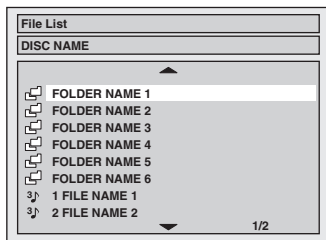

- To exit the menu, press [TITLE] again.

**2**  
Press [▲ / ▼] to select a desired folder (group) or track. Press [OK].

**When selecting track:**  
Playback will start.

**When selecting the folder:**  
The files in folder will appear.  
Press [▲ / ▼] to select the track or folder you want, then press [OK].

- Press [PLAY ►], [OK] or [▶] to move to the lower hierarchies.
- Press [◀] or [RETURN ↵] to the previous hierarchy.

### Hints for MP3 files:

- Folders are known as Groups, files are known as Tracks.
- Folders are accompanied by [folder icon] icon.
- MP3 files are accompanied by [MP3 icon] icon.  
Reproduction will start from the selected track and go to the next one in turn.
- The system can recognize up to 255 groups (or folders) and up to 999 tracks.
- The name of group and track can be displayed in up to 29 characters. Unrecognizable characters will be replaced with asterisks.
- If there are no files in the folder, "No Files" will be displayed.

**We recommends the files recorded under the following circumstances is played back:**

- Sampling frequency: 44.1kHz or 48kHz.
- Constant bit rate: 112kbps - 320kbps.

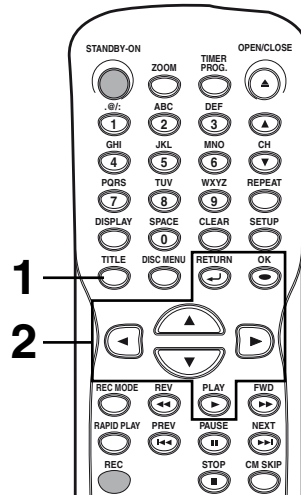

### Note

- The audio source of MP3 files cannot be recorded as digital sound by an MD or DAT deck.
- Files whose extension is other than ".mp3(MP3)" will not be listed in the MP3 menu.
- Some unplayable folders or tracks may be listed in the MP3 menu due to the recording status.

# Playing discs

## Basic playback (cont'd)

### Playing discs using the disc menu



A DVD disc contains a disc menu that describes the contents or allows you to customize the playback. For example, the menu may offer choices for subtitle languages, special features, or chapter selection. Sometimes these are displayed automatically when you start playback, otherwise only appear when you press [DISC MENU].

**1**  
Press [DISC MENU].  
Disc menu will appear.  
If the feature is not available, may appear on the TV screen.

**2**  
Using [ / / / ], select an item. Press [OK] to confirm.

Continue this step to set up all the features you want or to start playing the disc from the menu.

**DISC MENU button:**  
Displays a DVD disc menu which varies with the disc and may be the same as the 'Title list.'

**Cursor / / / buttons:**  
Moves the cursor around screen.

**OK button:**  
Selects the currently highlighted menu option.

**Number buttons:**  
Selects a numbered menu option (some discs only). (Press [OK] later.)

**3**  
Press [DISC MENU] to exit the disc menu.

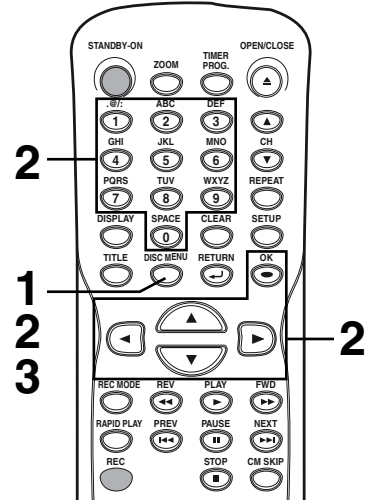

**Note**

- Menus vary among discs. Refer to the information accompanying the disc for details.

### Playing discs using the title menu



Some DVDs have a title menu, which lists the titles available on them. It helps you to start playback at a specific title.

**1**  
Press [TITLE].  
The title menu will appear.  
If the feature is not available, may appear on the TV screen.

**2**  
Using [ / / / ], select a title to play. Press [OK].  
Play will begin at the title you selected.

**TITLE button:**  
Displays the 'Title menu' of a DVD disc which varies with the disc.

**Cursor / / / buttons:**  
Moves the cursor around screen.

**OK button:**  
Selects the currently highlighted menu option.

**Number buttons:**  
Selects a numbered menu option (some discs only). (Press [OK] later.)

**3**  
Press [TITLE] to exit the title menu.

**For Video CDs:**  
When "PBC (Video CD only)" in the CD Playback Mode menu is "ON" and the display menu is not displayed, the Video CD main menu will appear when inserting a disc or press [RETURN ] during playback.

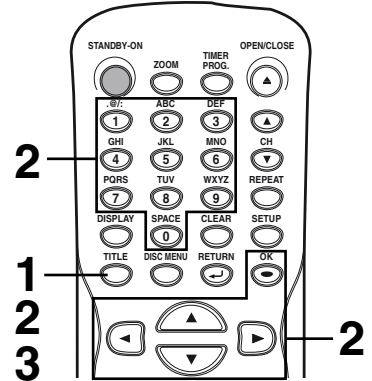

**Note**

- [TITLE] will not always be active with all DVDs.
- Menus vary among discs. Refer to the information accompanying the disc for details.

### Pause



**1**  
During playback, press [PAUSE ].  
Play will pause and sound will be muted.

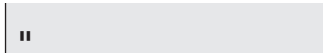

**2**  
Press [PLAY ] to resume play.

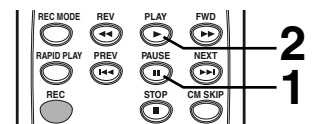

**Note**

- On DVDs, set "Still Mode" to "Field" in the Setup menu if pictures in the pause mode are blurred. (Refer to Page 68.)



# Playing discs

## Special playback

### Resume play



You can resume play from where you stopped playing the disc last.

In a few seconds, play will resume from the point at which it stopped last. You can resume play at the same point even if you turn off the unit.

**1**  
During playback, press [STOP ■].  
The resume message will appear.



**2**  
Press [PLAY ►].

To cancel the resume play and start playing the disc from the beginning, press [STOP ■] the second time while the play is stopped.

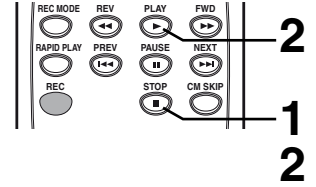

#### Note

- For MP3 files, playback will resume from the beginning of the track at which playback was stopped.
- Some Video CDs with the PBC function resume playback from the beginning of the track.

### Fast forward / Fast reverse



**1**  
During playback, press [FWD ►►] or [REV ◄◄].  
Every time you press [FWD ►►] or [REV ◄◄], approximate speed will be changed as follows.  
Fast forward or fast reverse playback across titles (for DVD discs) or tracks (for MP3) is not possible.



For Video CDs, approximate forward/reverse speeds are x2, x8, x16.  
For Audio CDs and MP3 files, approximate speed is fixed at x8 with sound.

To return to the normal play, press [PLAY ►].

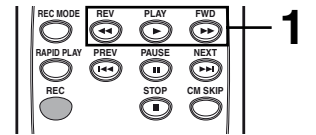

#### Note

- Forward/reverse speed will be indicated with icons as follows.  
Forward (Approx. Speed)  
x2: ►►  
x20: ►►►►  
x40: ►►►►►  
Reverse (Approx. Speed)  
x5: ◄◄◄  
x20: ◄◄◄◄  
x40: ◄◄◄◄◄

### Skipping TV commercials during play



You can skip TV commercials by pressing [CM SKIP], so that you can enjoy the recorded programs without interrupting.

You can press up to 6 times (180 seconds).  
e.g. Press [CM SKIP] once.

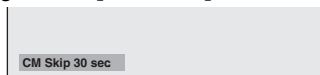

(forwarding 30 seconds)

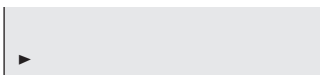

Playback will restart automatically.

**1**  
During playback, press [CM SKIP].  
Normal play will start at 30 seconds ahead from the point you press [CM SKIP].  
Every time you press [CM SKIP], the searching point will be extended by 30 seconds ahead.

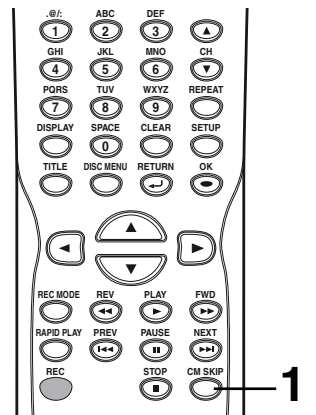



# Playing discs

## Special playback (cont'd)

### Rapid play



**Rapid Play function is available only during playback.**

Available only on discs recorded in the Dolby Digital format, Rapid Play plays back in a slightly faster/slower speed while keeping the sound quality just as normal playback.

**1**

During playback, press [RAPID PLAY].

▶ : Press [RAPID PLAY] once during playback. Plays back approximately at 0.8 times of normal playback.

▶ : Press [RAPID PLAY] twice during playback. Plays back approximately at 1.3 times of normal playback.

▶ : Press [RAPID PLAY] three times to play back in normal speed. No effects.

**2**

Press [PLAY ▶] to continue the normal playback.

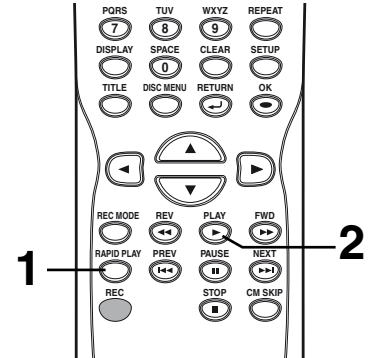

#### Note

- Audio (language) setting cannot be changed while using this mode.
- This feature may not work at some point in a disc.
- Audio is PCM during Rapid play mode.

### Step by step playback



**1**

During playback, press [PAUSE II]. Play will pause and sound will be muted.

**2**

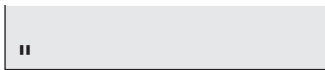

Press [NEXT ▶▶] repeatedly. The play will advance one frame (or step) at a time when you press [NEXT ▶▶] with the sound muted.

**To play step by step backward:** Press [PREV ◀◀] repeatedly. Every time you press the button, the play will go backward by one frame.

- Press and hold [PREV ◀◀] / [NEXT ▶▶] to reverse/ advance continuously.

**3**

Press [PLAY ▶] to continue the normal playback.

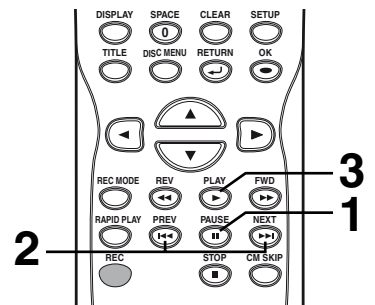

#### Note

- Only step by step forward playback is available for playing back Video CDs.

### Slow forward / Slow reverse play



**1**

During playback, press [PAUSE II]. Then press [FWD ▶▶] or [REV ◀◀]. Every time you press [FWD ▶▶] or [REV ◀◀], approximate speed will be changed as follows. (The sound will remain muted.)

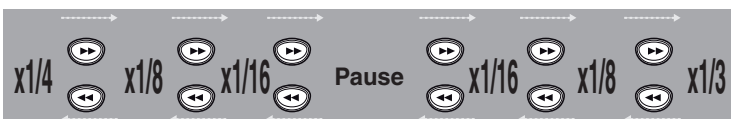

To return to the normal play, press [PLAY ▶].

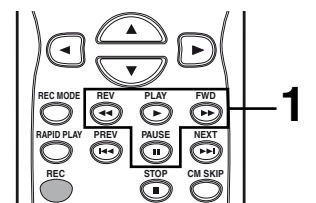

#### Note

- Forward/reverse speed will be indicated with icons as follows.  
Forward (Approx. Speed)  
x1/16:   
x1/8:   
x1/3:   
Reverse (Approx. Speed)  
x1/16:   
x1/8:   
x1/4:
- Only slow forward playback is available for playing back Video CDs.

# Playing discs

## Special playback (cont'd)

### Zoom



**1**  
During playback, press [DISPLAY] or [ZOOM].  
Display menu will appear.

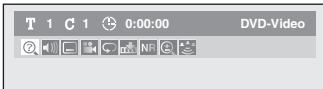

**2**  
Using [◀/▶], select . Press [OK].  
Zoom menu will appear.

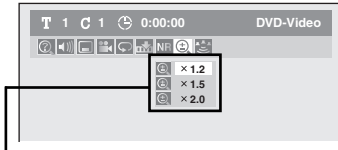

There are four options (x1.0, x1.2, x1.5 and x2.0), these are displayed excluding the current zoom rate.

**3**  
Using [▲/▼], select a desired zoom factor to zoom. Press [OK].  
The zoom area will be displayed.

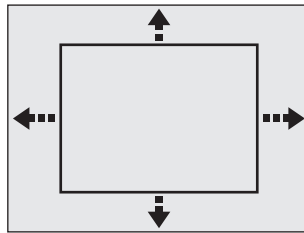

**4**  
Using [▲/▼/◀/▶], select a desired zoom position. Press [OK].  
The zoom play will start.

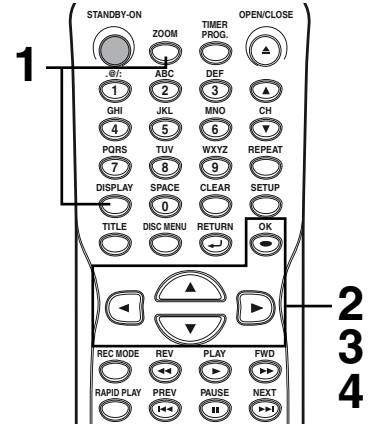

#### Note

- When selecting a smaller factor than the current one, the zoom area will not be displayed.
- To exit the zoom menu, press [DISPLAY] or [ZOOM] again at step 1.
- To cancel the zoom function, select "x1.0" using [▲/▼], then press [OK].

### Marker Setup



This feature allows you to assign a specific point on a disc to be called back later.

**1**  
During playback, press [DISPLAY].  
Display menu will appear.

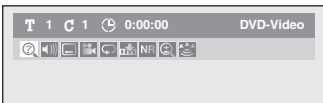

**2**  
Using [◀/▶], select . Press [OK].  
Marker setup menu will appear.

When inserting <DVD-Video> disc.

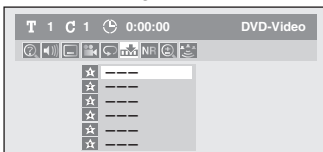

When inserting <Audio CD> disc.

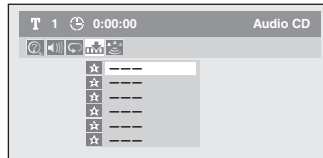

**3**  
Using [▲/▼], select a desired marker number. When it reaches the desired point, press [OK].  
The title (track) number and the time will be displayed.

**4**  
To return to the marker later:  
Using [▲/▼], select the desired marker number. Press [OK].

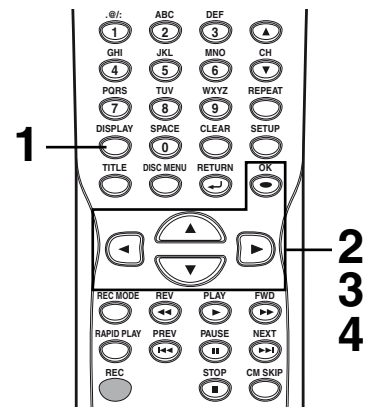

#### Note

- To clear a marker, select the marker number to be cleared, then press [CLEAR].
- All markers will be erased when you operate these operations listed below.
  - Opening the disc tray
  - Turning off the power
  - Recording to a recordable disc
- You can mark up to 6 points.
- Marker Setup is not available when you play the Video CD with PBC function.

# Playing discs

## Search

### Title/Chapter search



Using [PREV ◀◀] / [NEXT ▶▶]

1

During playback, press [NEXT ▶▶] to skip the current title or chapter and move to the next.

The title or chapter will move forward by one at a time.

- If there is no chapter in one title, the current title will be skipped.

To go back to the beginning of the current title or chapter, press [PREV ◀◀].

Press it repeatedly to go to the previous title or chapter. The title or chapter will move backward one title at a time.

Using [DISPLAY]

1

During playback, press [DISPLAY].

Display menu will appear.

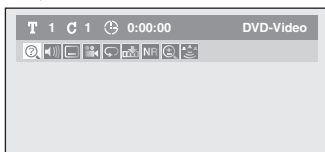

2

Using [◀ / ▶], select . Press [OK].

The number next to **T** will be highlighted.

**Title:**

Using [▲ / ▼] or the Number buttons, enter a desired title number to search. Press [OK].

Title search will start.

**Chapter:**

Press [▶] to move to the number next to **C** for chapter.

Using [▲ / ▼] or the Number buttons, enter a desired chapter number to search. Press [OK].

Chapter search will start.

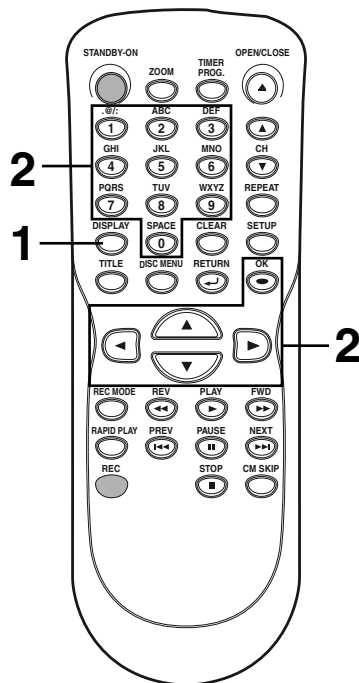
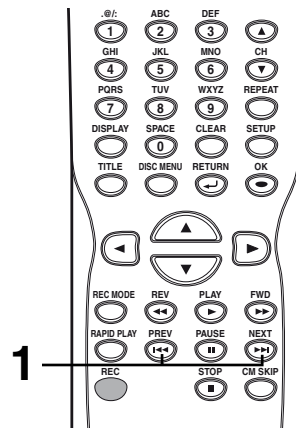

### Note

- In search mode display, total numbers of each search contents (title/chapter/time) are shown as a denominator.

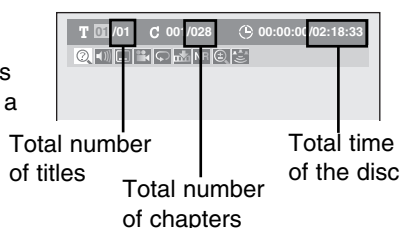

# Playing discs

## Search (cont'd)

### Track search



Using [PREV ◀◀] / [NEXT ▶▶]

1

During playback, press [NEXT ▶▶] to skip the current track and move to the next.

The track will move forward one at a time.

To go back to the beginning of the current track, press [PREV ◀◀].

Press it repeatedly to go to the previous track. The track will move backward one at a time.

Using [DISPLAY]

1

During playback, press [DISPLAY].

Display menu will appear.

When inserting <Audio CD> disc.

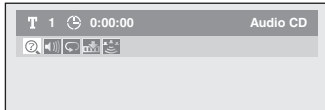

When inserting <MP3 files> disc.

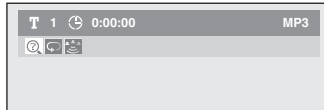

2

Using [◀/▶], select . Press [OK].

The number next to **T** will be highlighted.

3

Using [▲ / ▼] or the Number buttons, enter a desired track number to search. Press [OK].

Track search will start.

### Time search



1

During playback, press [DISPLAY].

Display menu will appear.

When inserting <DVD-Video> disc.

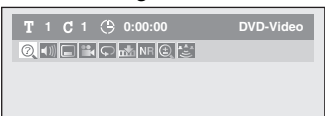

When inserting <Audio CD> disc.

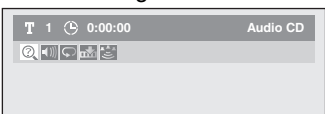

2

Using [◀/▶], select . Press [OK].

The number next to **T** will be highlighted.

To move to the number next to , press [▶].

When time search is not available, and time counter are not displayed.

3

Using [▲ / ▼] or the Number buttons, enter a desired time to search. Press [OK].

Time search will start.

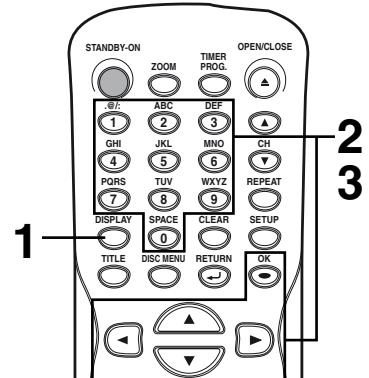
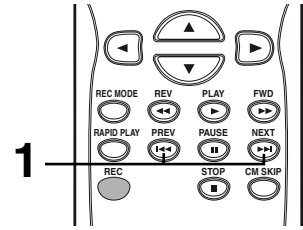

#### Note

- During CD playback you can enter a track number directly using **the Number buttons** for track search without displaying the menu.
- Track search is not available when you play the Video CD with PBC function.

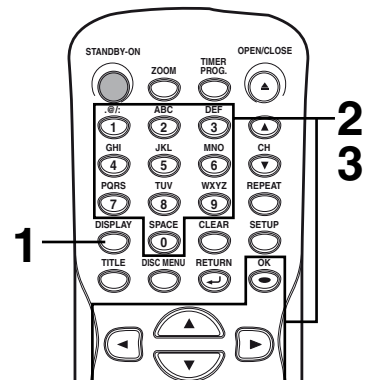

#### Note

- Time search function is available only in the same track or title.
- Time search is not available when you play the Video CD with PBC function.

# Playing discs

## Repeat/Random/Program playback

### Repeat playback



**1**  
During playback, press [DISPLAY] or [REPEAT].  
Display menu will appear.

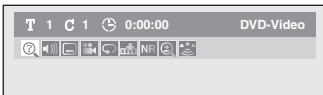

**2**  
Using [◀/▶], select . Press [OK].  
Repeat menu will appear.

When inserting <DVD-Video> disc.

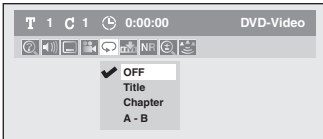

When inserting <Audio CD, Video CD> disc.

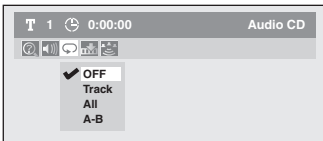

When inserting <MP3 files> disc.

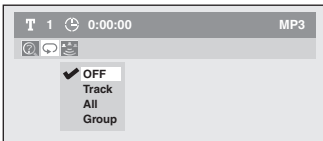

**3**  
Using [▲ / ▼], select a desired option to repeat. Press [OK].  
The selected repeat play will start.

**Title:**  
The current title will be played repeatedly. (DVD only)

**Chapter:**  
The current chapter will be played repeatedly. (DVD only)

**All:**  
The current disc will be played repeatedly. (CD, MP3, Video CD)

**A-B:**  
The A-B point will be played repeatedly.  
When pressing [OK] while A-B is highlighted, A-B repeat is set. Press [OK] again to decide the starting point (A). Press [OK] after setting point A to select the ending point (B).

**Track:**  
The current track will be played repeatedly. (CD, MP3, Video CD)

**Group:**  
The current group will be played repeatedly. (MP3 only)

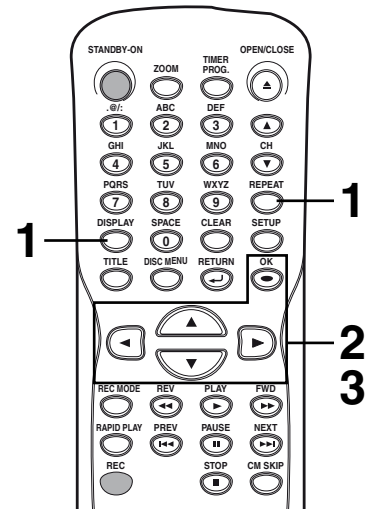

#### Note

- The A-B Repeat playback can only be set with in the current title (for DVDs), or current track (for Audio CDs).
- To cancel the repeat playback, select "OFF" at the step 2. The repeat setting will also be canceled when you stop playback.
- You cannot select "Group" during the random playback of MP3 files.
- Repeat playback is not available when you play the Video CD with PBC function.

### Random playback



With this function, you can play a disc randomly instead of playing in the original order.

**1**  
Press [SETUP].

**2**  
Using [▲ / ▼], select "CD Playback Mode". Press [OK].  
CD Playback Mode menu will appear.

**3**  
Using [▲ / ▼], select "Random Play". Press [OK].  
Random playback will start.

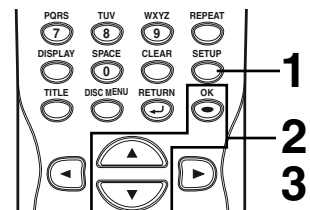

#### Note

- To cancel random playback, press [STOP ■] twice during random playback. "Play mode OFF" appears on the TV screen.
- For Video CDs with PBC function, the PBC setting will be switched to off automatically when you start random playback.

# Playing discs

## Repeat/Random/Program playback (cont'd)

### Program playback



You can program the disc to play in your desired order.

**1**  
Press [SETUP].

**2**  
Using [▲ / ▼], select “CD Playback Mode”. Press [OK]. CD Playback Mode menu will appear.

**3**  
Using [▲ / ▼], select “Program Play”. Press [OK]. Program play list will appear.

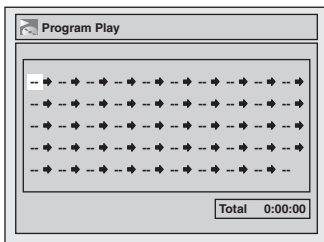

**4**  
Using [▲ / ▼], select a desired track. Press [OK] or [▶]. A cursor will move to next.

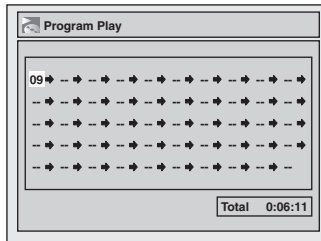

**5**  
Press [PLAY ▶] to start program playback. Program playback will start.

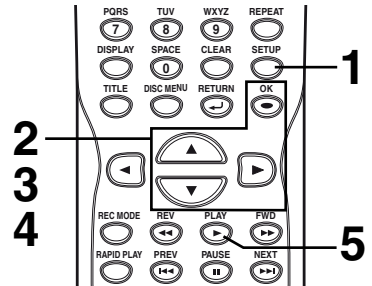

#### Note

- To erase tracks you selected, press [CLEAR].
- You can make program settings up to 50.
- To cancel program playback, press [STOP ■] twice during program playback. “Play mode OFF” appears on the TV screen.
- You may also select a desired track using the **Number buttons** at step 4.
- For Video CDs with PBC function, the PBC setting will be switched to off automatically when you start program playback.

## Selecting the format of audio and video

You can select the format of audio and video as you prefer depending on the contents of the disc you are playing.

### Switching subtitles



Many DVD-Video discs have subtitles in one or more languages – the case usually tells you which subtitle languages are available. You can switch subtitle languages anytime during playback.

**1**  
During playback, press [DISPLAY]. Display menu will appear.

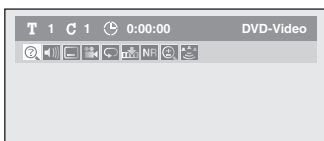

**2**  
Using [◀ / ▶], select . Press [OK]. Subtitle menu will appear.

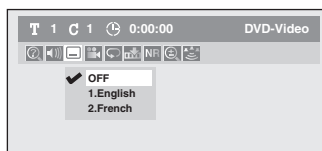

**3**  
Using [▲ / ▼], select a desired subtitle language. Press [OK]. Subtitle will be displayed in the selected language. When selecting “OFF”, subtitle will disappear.

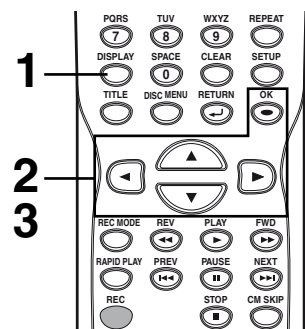

#### Note

- Some discs will only allow you to change the subtitle from the disc menu. Press [TITLE] or [DISC MENU] to display the disc menu.
- If a 4-digit language code appears in the subtitle menu at step 2, refer to the Language code on page 74.



# Playing discs

## Selecting the format of audio and video (cont'd)

### Switching audio soundtrack



When playing a DVD-Video disc recorded with two or more soundtracks (these are often in different languages), you can switch them during playback. When playing Video CDs or Audio CDs, you can switch between stereo, just the left channel or just the right channel.

**1**

During playback, press [DISPLAY].  
Display menu will appear.

**2**

Using [◀/▶], select . Press [OK].  
Audio menu will appear.

When inserting <DVD-Video> disc.

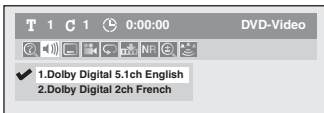

When inserting <Audio CD> disc.

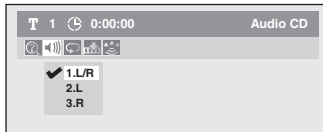

**3**

Using [▲/▼], select a desired audio soundtrack or audio channel. Press [OK].

When inserting <DVD-Video> disc.  
Audio soundtrack will switch.

When inserting <Video CDs/Audio CDs> disc.  
Audio channel will switch.

**4**

Using [▲/▼], select a desired audio channel. Press [OK].  
Audio channel will switch.

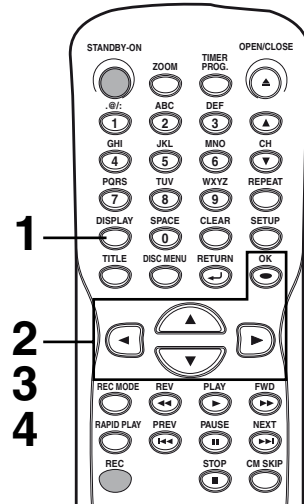

#### Note

- Some discs will only allow you to change the soundtrack from the disc menu. Press [TITLE] or [DISC MENU] to display the disc menu.
- This unit CANNOT record in both stereo and SAP (Secondary Audio Program) at the same time.

### Switching virtual surround system



You can enjoy stereophonic virtual space through your exciting 2 channel stereo system.

**1**

During playback, press [DISPLAY].  
Display menu will appear.

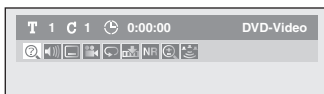

**2**

Using [◀/▶], select . Press [OK].

Virtual Surround menu will appear.

When inserting <DVD-Video> disc.

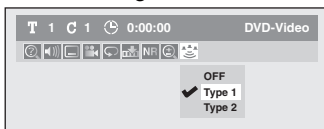

When inserting <DVD+RW> disc.

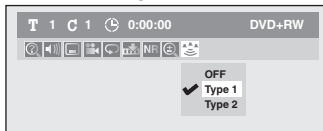

When inserting <Audio CD/MP3 files> disc.

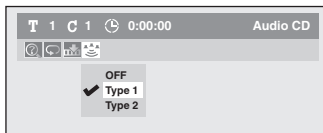

**3**

Using [▲/▼], to select "OFF", "Type 1" or "Type 2", then press [OK].

- OFF: no effect
- Type 1: natural effect
- Type 2: emphasized effect

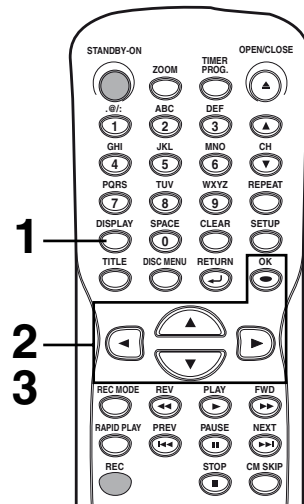

#### Note

- Select Virtual Surround to "OFF" in case sound is distorted.
- The setting will be kept "OFF" when the unit is turned off.



# Playing discs

## Selecting the format of audio and video (cont'd)

### Switching camera angles



Some DVD-Video discs feature scenes shot from two or more angles, check the case for details: it should be marked with Angle icon if it contains multi-angle scenes.

**1**  
During playback, press [DISPLAY].

Display menu will appear.

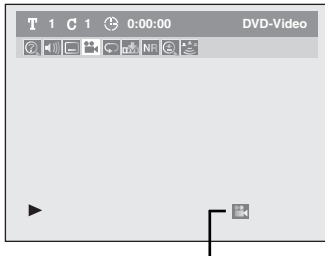

Angle icon appears when a switching camera angle is available.

**2**  
Using [◀/▶], select . Press [OK].

Angle will switch each time you press [OK].

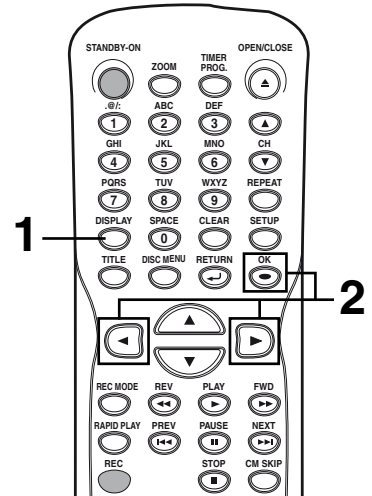

#### Note

Angle icon does not appear on the screen if you have selected Angle as "OFF" in the Display setting. Refer to pages 65-66.

### Reducing block noise



**1**  
During playback, press [DISPLAY].

Display menu will appear.

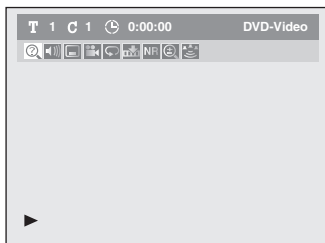

**2**  
Using [◀/▶], select . Press [OK].

Noise Reduction menu will appear.

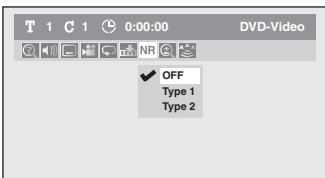

**3**  
Using [▲/▼], select a desired option. Press [OK].

Your setting will be activated.

This function reduces noise in the playback picture. When playing back discs recorded in long time mode such as EP or SLP mode, select "Type 1" or "Type 2". ("Type 2" is more effective.) When playing back discs with a few noises such as DVD-Video discs, select "OFF".

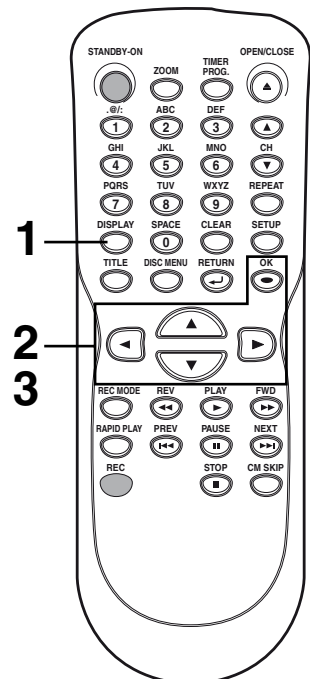

### Guide to a title list

Title list allows you to check the titles recorded on the disc easily. You can choose a title to play from this list and easily edit the titles as you prefer.

Press [TITLE].

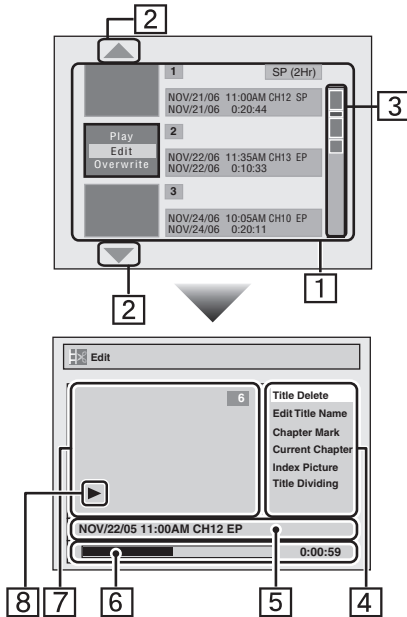

1. Titles recorded on the disc can be selected to edit by pressing [OK] with the cursor on the title. Using [▲ / ▼], select "Edit". Press [OK].
2. The arrow icon, which means the title list includes a next or a previous page. Press [▲ / ▼] by following direction of the icon. You can also use [◀ / ▶] to go to the next/previous page.
3. The portion bar, which indicates the position of the disc.
4. The menus in here for editing as you prefer. The available menus depend on the disc type and the format type. An item which is not available is grayed.
5. The details of the title, which can be changed to the title name you will edit.
6. Time status bar of the title.  
Time status will be held even after exiting the edit mode, and you can resume playback from that point.
7. The selected title thumbnail from the title list.
8. Playback status of the current title.

### Editing discs

You can edit discs for the following items. Be sure that once you edit titles, they will not remain as original.

- Deleting titles (Refer to page 52)
- Putting names on titles (Refer to page 53)
- Setting chapter marks (Refer to page 54)
- Clearing chapter marks (Refer to pages 54-55)
- Hiding chapters (Refer to page 56)
- Setting pictures for thumbnails (Refer to page 57)
- Dividing a title (DVD+RW/DVD-RW only) (Refer to page 58)

#### Note

- When selecting "Edit" on Pop-up menu of the title list and edit the title, the title list is displayed after writing the edited contents onto the disc. Press [STOP ■] to exit the title list.

### Editing discs (Setup menu)

- Putting name on disc (Refer to page 59)
- Setting or releasing disc protect (Refer to pages 60-61)
- Erasing disc (Refer to page 62)
- Making edits compatible (Refer to page 62)

#### Note

- The portion bar in the right side of the title list may not indicate the precise position in the disc.
- The portion bar may not indicate the position for the titles of which recording time is short.
- Once a disc is finalized, editing the disc or recording to the disc will not be available.

# Editing

## Editing discs

### Deleting titles



You can delete titles which you do not need anymore.

Be advised that the titles once deleted cannot be brought back to the disc.

When the last title, which is recorded in the disc, in the title list is deleted, the disc space to record on will be increased. For DVD+R and DVD-R disc, the disc space to record on will not be changed.

**1**

Press [TITLE].

Title list will appear.

When inserting

<DVD+RW/DVD-RW> disc.

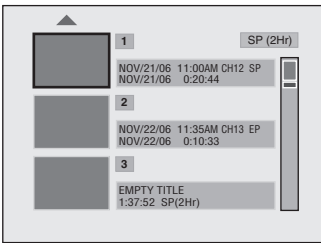

**2**

Using [▲ / ▼], select a desired title. Press [OK].

Pop-up window will appear.



**3**

Using [▲ / ▼], select "Edit". Press [OK].

Edit menu will appear.

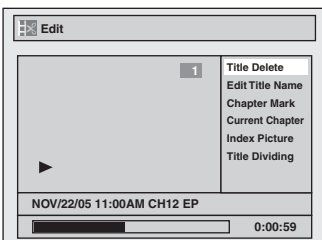

**4**

Using [▲ / ▼], select "Title Delete". Press [OK].

Confirmation window will appear.

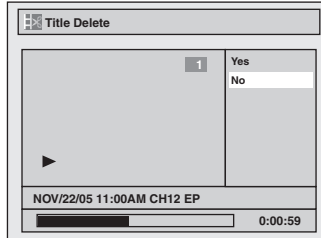

**5**

Using [▲ / ▼], select "Yes". Press [OK].

After that, "Are you sure?" will appear, select "Yes" and then press [OK].

Title will be deleted.

Data will be written onto the disc momentarily.



Title list will appear.

When inserting

<DVD+RW/DVD-RW> disc.

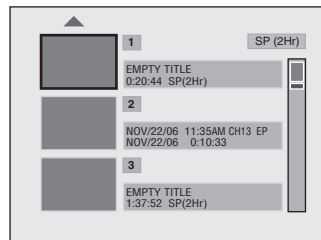

When inserting

<DVD+R/DVD-R> disc.

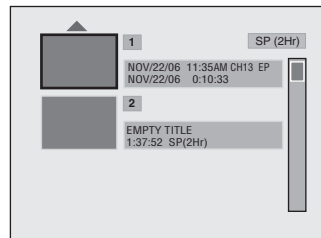

**This operation may take a while to be completed.**

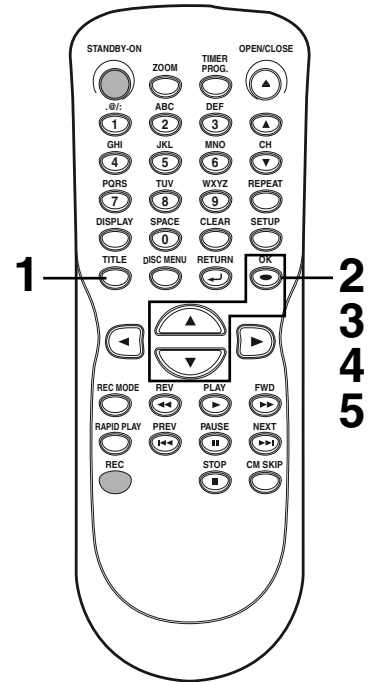

#### Note

- Deleted part of the titles in the portion bar changes in color.

# Editing

## Editing discs (cont'd)

### Putting names on titles



You can put title names on the titles and change the names from this menu.

The names you put on the titles will be displayed on a title list.

**1**

Follow steps 1 to 3 in “Deleting titles” on page 52 to display the Edit menu.

**2**

Using [▲ / ▼], select “Edit Title Name”. Press [OK].

A window for entering a title name will appear.

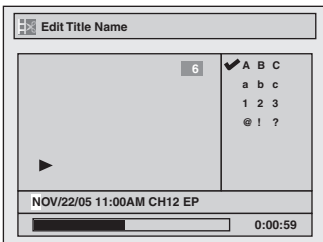

**3**

To enter a title name, follow the steps of “Guide to edit title name” on this page.

character set

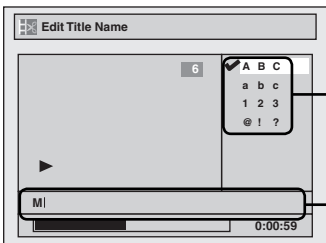

area for entering title names

When you finish entering a title name, press [OK].

Confirmation window will appear.

**4**

Using [▲ / ▼], select “Yes”. Press [OK].

The name you entered will be activated for the title.

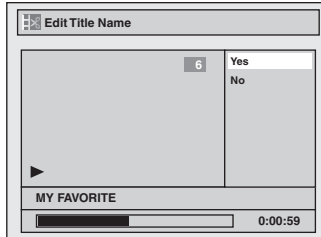

**5**

After this operation is completed, press [RETURN↵] to exit.

Data will be written onto the disc momentarily.

**This operation may take a while to be completed.**

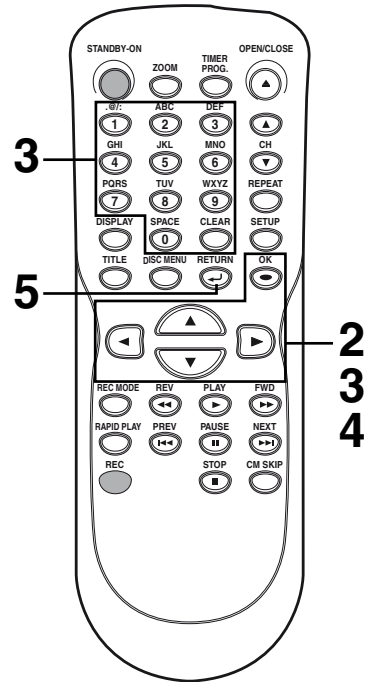

### [ Guide to edit title name ]

**[Step1]:** Select a desired character set using [▲/▼], then press [OK].

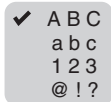

**[Step2]:** Follow the list below, press the **Number buttons** repeatedly until the desired letter appears.  
e.g. character set : A B C

Select Press	ABC	abc	123	@ ! ?
0	<space>	<space>	0	<space>
1	(*1)	(*1)	1	! " # \$ % & ' ( ) * + , - . / : ; < = > ? @ [ ] ^ _ {   }
2	ABC	abc	2	(*2)
3	DEF	def	3	(*2)
4	GHI	ghi	4	(*2)
5	JKL	jkl	5	(*2)
6	MNO	mno	6	(*2)
7	PQRS	pqrs	7	(*2)
8	TUV	tuv	8	(*2)
9	WXYZ	wxyz	9	(*2)

**Note:** Undefined letters in a title name are shown by “\*”. If you delete them, adjoining letters may change to “\*” or other.

\*1 Press ①, character set will be changed to the “@!?” mode automatically.

\*2 Press ② to ⑨, character set will be changed to the previous input mode automatically.

- To delete letters, press [CLEAR] repeatedly. Holding [CLEAR] to delete all letters.
- Press [◀/▶] to move the cursor to the left and right.
- You can enter up to 30 letters.

# Editing

## Editing discs (cont'd)

### Setting chapter marks



You can put chapter marks in each title. Once a chapter is marked, you can use it for the chapter search feature.

**1**

Follow steps 1 to 3 in "Deleting titles" on page 52 to display the Edit menu.

**2**

Using **[▲ / ▼]**, select "Chapter Mark". Press **[OK]**.

Option window will appear.

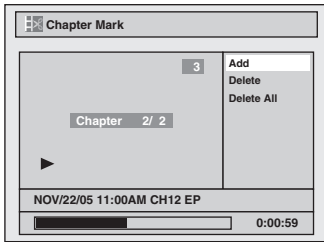

**3**

Press **[PLAY ►]** and then **[PAUSE II]** to decide the point at which you will create a new chapter mark.

- It is convenient to use **[PREV ◀◀]**, **[NEXT ▶▶]**, **[REV ◀◀]** and **[FWD ▶▶]** for finding the point at which a new chapter mark is to be added.

**4**

Using **[▲ / ▼]**, select "Add". Press **[OK]**.

Confirmation window will appear.

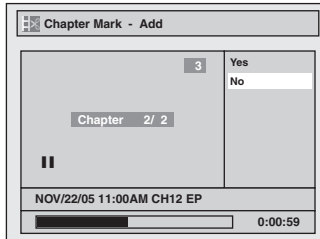

**5**

Using **[▲ / ▼]**, select "Yes". Press **[OK]**.

A new chapter mark will be added.

**6**

Press **[RETURN ↵]** twice to exit. Data will be written onto the disc momentarily.

**This operation may take a while to be completed.**

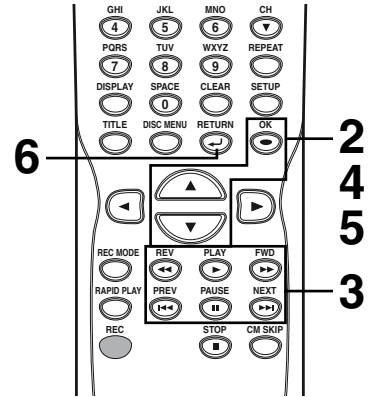

#### Note

- When the number of chapter marks in a title is 49 and the number of chapter marks in a disc is 254, chapter marks cannot be added.
- Besides the above-mentioned, it is not likely to be able to add according to recorded time and number of chapters.
- Remaining time of the disc may decrease when adding chapter marks or increase when clearing chapter marks depending on the recording time or edited contents.

### Clearing chapter marks



**1**

Follow steps 1 to 3 in "Deleting titles" on page 52 to display the Edit menu.

**2**

Using **[▲ / ▼]**, select "Chapter Mark". Press **[OK]**.

Option window will appear.

**3**

Using **[PREV ◀◀]** / **[NEXT ▶▶]**, select a chapter mark to be deleted.

**4**

Using **[▲ / ▼]**, select "Delete". Press **[OK]**.

Confirmation window will appear.

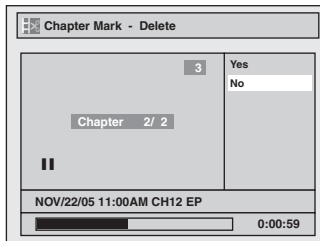

**5**

Using **[▲ / ▼]**, select "Yes". Press **[OK]**.

The selected chapter mark will be deleted.

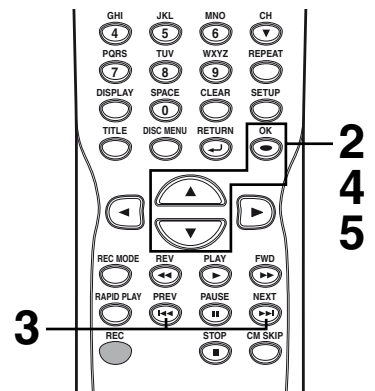

#### Note

- Remaining time of the disc may decrease when adding chapter marks or increase when clearing chapter marks depending on the recording time or edited contents.

### Clearing chapter marks (cont'd)

**6**

Press [RETURN↵] twice to exit.  
Data will be written onto the disc momentarily.

**This operation may take a while to be completed.**

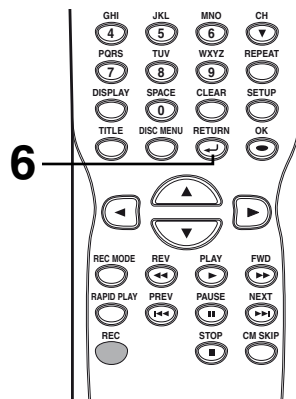

To delete all chapter marks:

**1**

Follow steps 1 to 3 in “Deleting titles” on page 52 to display the Edit menu.

**2**

Using [▲ / ▼], select “Chapter Mark”. Press [OK].

Option window will appear as illustrated step 2 on page 54.

**3**

Using [▲ / ▼], select “Delete All”. Press [OK].

Confirmation window will appear.

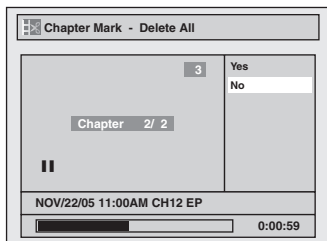

**4**

Using [▲ / ▼], select “Yes”. Press [OK].

Final confirmation window will appear.

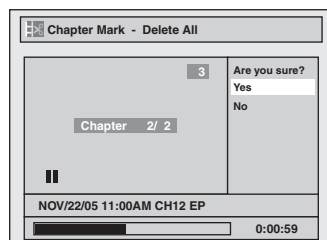

**5**

Using [▲ / ▼], select “Yes”. Press [OK].

All chapter marks will be deleted.

**6**

Press [RETURN↵] twice to exit.  
Data will be written onto the disc momentarily.

**This operation may take a while to be completed.**

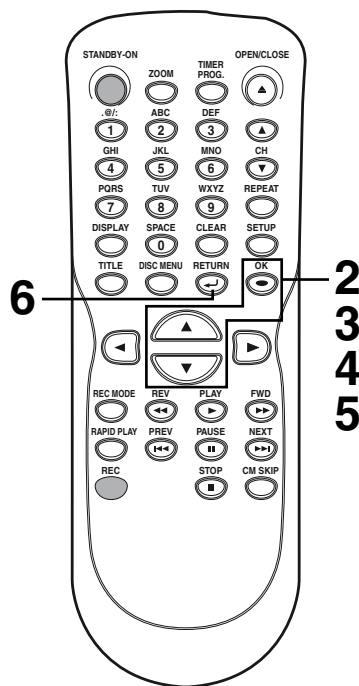

**Note**

- Remaining time of the disc may decrease when adding chapter marks or increase when clearing chapter marks depending on the recording time or edited contents.

### Hiding chapters



You can hide chapters from the title list.

Hidden chapters are skipped during playback.

**1**

Follow steps 1 to 3 in “Deleting titles” on page 52 to display the Edit menu.

**2**

Using [▲ / ▼], select “Current Chapter”. Press [OK].

Option window will appear.

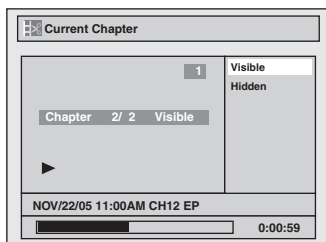

**3**

Using [PREV ◀◀] / [NEXT ▶▶], [PLAY ▶] and [PAUSE II], decide the chapter to be hidden.

**4**

Using [▲ / ▼], select “Hidden”. Press [OK].

“Hidden” is displayed in the middle of the preview screen on Current chapter window.

“Hidden” is also displayed on the lower right corner of the preview screen on Edit menu option window other than Current chapter window.

**5**

After this operation is completed, press [RETURN↵] twice to exit.

Data will be written onto the disc momentarily.

**This operation may take a while to be completed.**

If you want to return “Visible”, select the chapter to be shown. Then using [▲ / ▼], select “Visible” at the step 2 on this page.

Data will be written onto the disc momentarily.

After that title list is displayed.

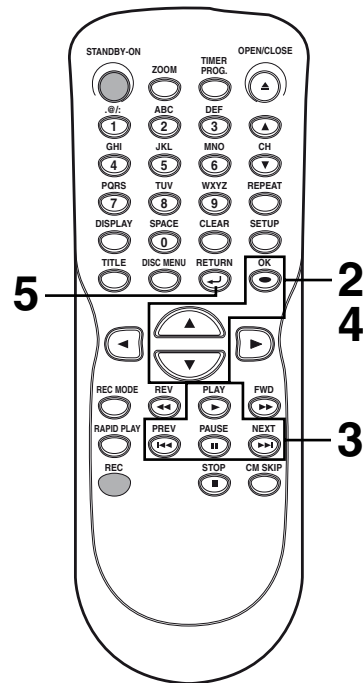

#### Note

- When you make all chapters in the title to “Hidden”, “Hidden” is displayed in a thumbnail of the title list.

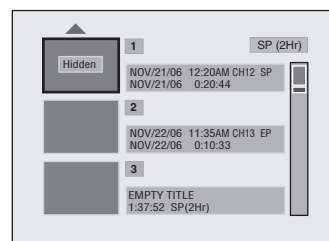



# Editing

## Editing discs (cont'd)

### Setting pictures for thumbnails



You can set a picture to each title for a thumbnail. It helps you to remember the contents of the title you are playing. The beginning picture has been selected as the default.

**1**

Follow steps 1 to 3 in "Deleting titles" on page 52 to display the Edit menu.

**2**

Use [PREV ◀◀], [NEXT ▶▶], [REV ◀], [FWD ▶], [PAUSE ||] and [PLAY ▶] to decide the picture you want to select as a thumbnail.

**3**

Using [▲ / ▼], select "Index Picture". Press [OK].

Confirmation window will appear.

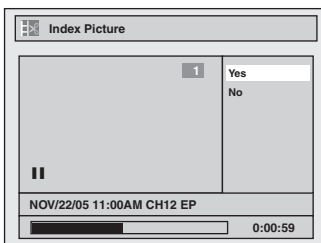

**4**

Using [▲ / ▼], select "Yes". Press [OK].

A picture for thumbnail will be set.

**5**

Press [RETURN ↵] to exit.

Data will be written onto the disc momentarily.

**This operation may take a while to be completed.**

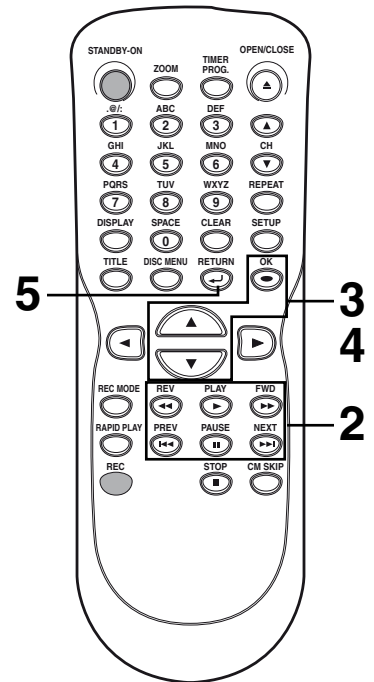

Before you start

Connections

Getting started

Recording

Playing discs

Editing

Changing the Setup menu

Others

Español

#### Note

- If the selected picture for a thumbnail is overwritten a default picture will be selected.

# Editing

## Editing discs (cont'd)

### Dividing a title



You can divide one title into two new titles.

**1**

Follow steps 1 to 3 in “Deleting titles” on page 52 to display the Edit menu.

**2**

Use [PREV ◀◀], [NEXT ▶▶], [REV ◀], [FWD ▶], [PAUSE ||] and [PLAY ▶] to decide the point at which you will divide the title.

**3**

Using [▲ / ▼], select “Title Dividing”. Press [OK].

Confirmation window will appear.

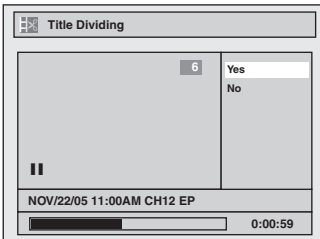

**4**

Using [▲ / ▼], select “Yes”. Press [OK].

The title will be divided into two new titles.

Both title names are identical, and index pictures are reset to the first scene at this point.

Data will be written onto the disc momentarily.

**This operation may take a while to be completed.**

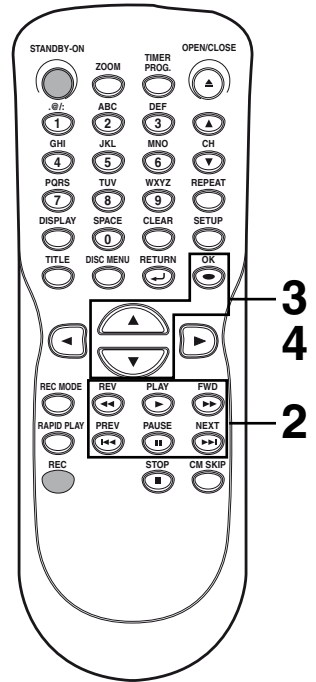

#### Note

- You cannot divide a title of the disc on which the number of recording title comes up to the maximum (49), and the number of recording chapter comes up to the maximum (254).

# Editing

## Editing discs (Setup menu)

### Putting name on disc



You can put title names on the titles and change the names from this menu.

Press **[STOP ■]** if you are playing a disc.

**1**  
Press **[SETUP]**.

**2**  
Using **[▲ / ▼]**, select “Disc Edit”. Press **[OK]**.

Disc Edit menu will appear.

When inserting <DVD+RW> disc.

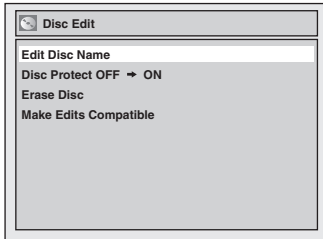

When inserting <DVD+R/DVD-R> disc.

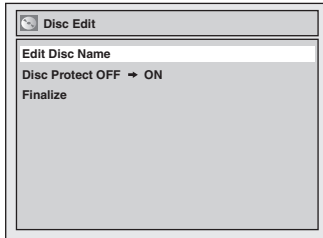

When inserting <DVD-RW> disc.

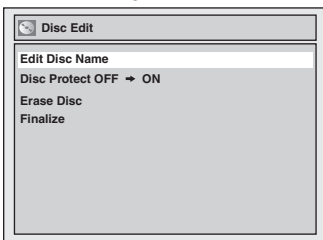

**3**  
Using **[▲ / ▼]**, select “Edit Disc Name”. Press **[OK]**.

A window for entering a title name will appear.

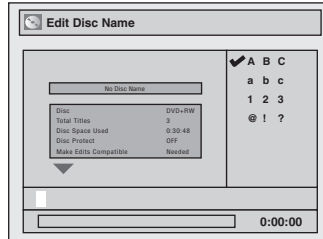

**4**  
To enter a disc name, follow the steps of “Guide to edit title name” on page 53.

When you finish entering a title name, press **[OK]**.

Confirmation window will appear.

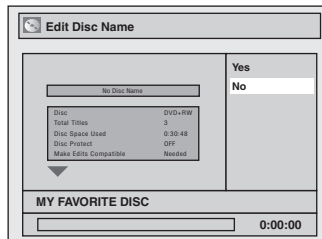

**5**  
Using **[▲ / ▼]**, select “Yes”. Press **[OK]**.

The name you entered will be activated for the title. Data will be written onto the disc momentarily.

**This operation may take a while to be completed.**

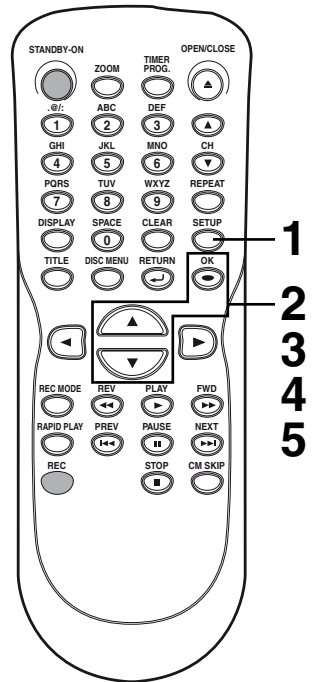

Before you start

Connections

Getting started

Recording

Playing discs

Editing

Changing the Setup menu

Others

Español

#### Note

- You cannot select “Disc Edit” when finalized DVD disc is inserted (DVD+R/DVD-R).

# Editing

## Editing discs (Setup menu) (cont'd)

### Setting or releasing disc protect



To prevent accidental editing, or erasing the titles, you can protect them.

**1**

Follow steps 1 to 2 in “Putting name on disc” on page 59 to display the Disc Edit menu.

When inserting <DVD+RW> disc.

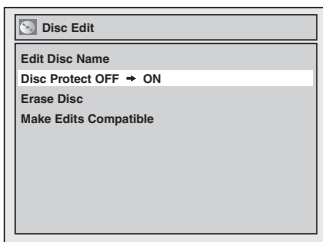

When inserting <DVD+R/DVD-R> disc.

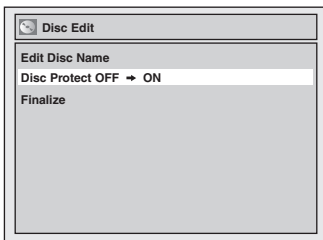

When inserting <DVD-RW> disc.

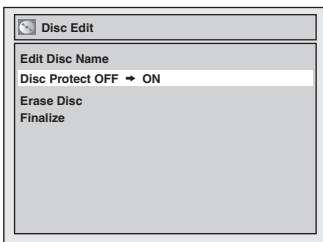

**2**

Using [▲ / ▼], select “Disc Protect OFF → ON”. Press [OK]. Confirmation window will appear.

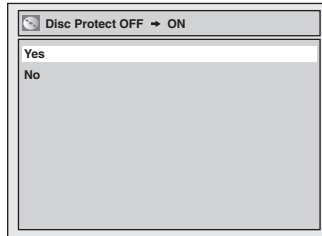

**3**

Using [▲ / ▼], select “Yes”. Press [OK].

Data will be written onto the disc momentarily.

**This operation may take a while to be completed.**

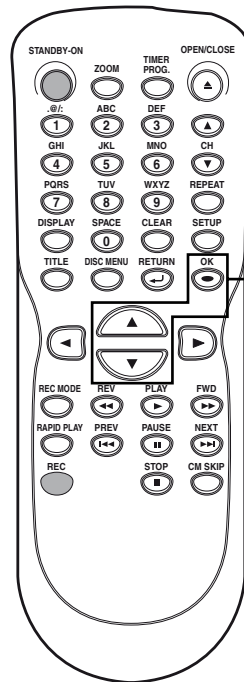

Instructions continue on the next page.

### Setting or releasing disc protect (cont'd)

#### Releasing disc from protect

**1**

Follow steps 1 to 2 in "Putting name on disc" on page 59 to display the Disc Edit menu.

When inserting <DVD+RW> disc.

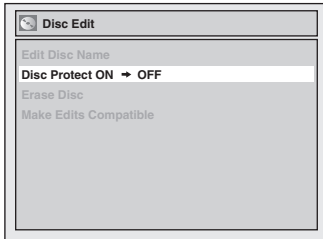

When inserting <DVD+R/DVD-R> disc.

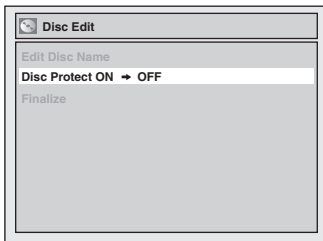

When inserting <DVD-RW> disc.

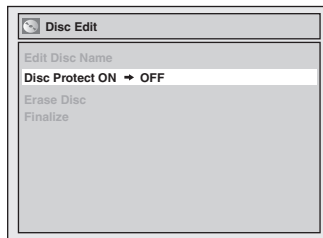

**2**

Using [▲ / ▼], select "Disc Protect ON → OFF". Press [OK]. Confirmation window will appear.

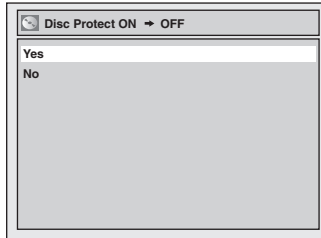

**3**

Using [▲ / ▼], select "Yes". Press [OK].

Data will be written onto the disc momentarily.

**This operation may take a while to be completed.**

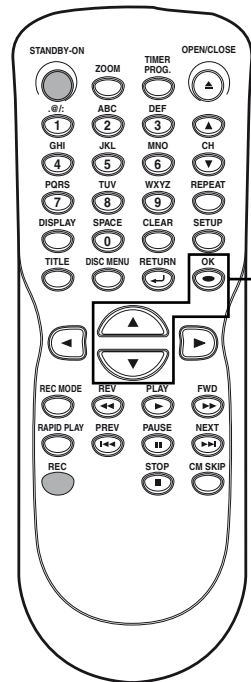

# Editing

## Editing discs (Setup menu) (cont'd)

### Erasing disc



You can erase all titles on a disc. If you want to record on DVD-RW formatted with other than DVD+VR mode, erase all contents on the disc it will be recorded to DVD+VR automatically.

Press **[STOP ■]** if you are playing a disc.

**1**

Follow steps 1 to 2 in “Putting name on disc” on page 59 to display the Disc Edit menu.

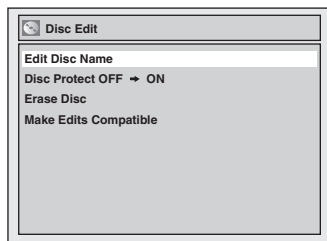

**2**

Using **[▲ / ▼]**, select “Erase Disc”. Press **[OK]**. Confirmation window will appear.

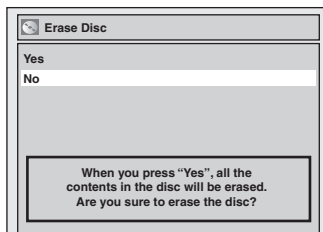

**3**

Using **[▲ / ▼]**, select “Yes”. Press **[OK]**. Data will be written onto the disc momentarily.

**This operation may take a while to be completed.**

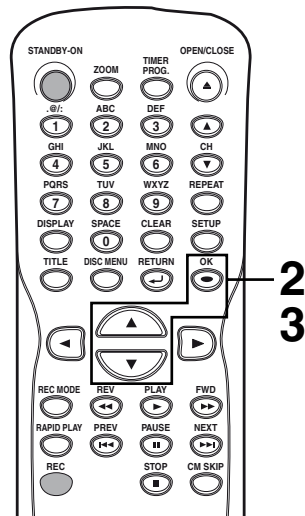

#### Note

- When you press “Yes”, all contents of the disc will be erased.
- When a disc is erased all of the contents will be lost. (Its format will be changed to DVD+VR mode.)
- If you want to cancel erasing the disc at step 2, select “No”.

### Making edits compatible



You will need to select “Make Edits Compatible” to play in other DVD players.

Press **[STOP ■]** if you are playing a disc.

**1**

Follow steps 1 to 2 in “Putting name on disc” on page 59 to display the Disc Edit menu.

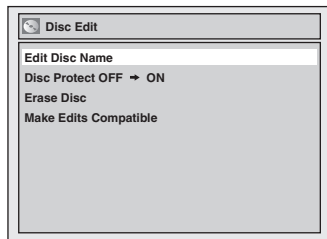

**2**

Using **[▲ / ▼]**, select “Make Edits Compatible”. Press **[OK]**. Confirmation window will appear.

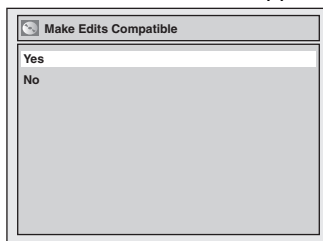

**3**

Using **[▲ / ▼]**, select “Yes”. Press **[OK]**. Data will be written onto the disc momentarily.

**This operation may take a while to be completed.**

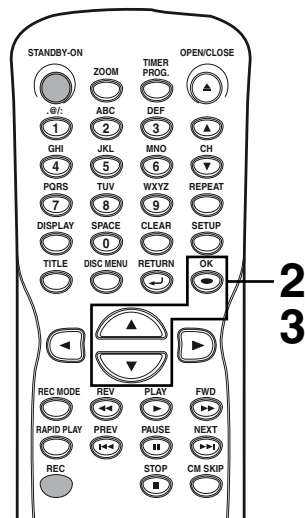

#### Note

- If “Make Edits Compatible” is not selectable in “Disc Edit” menu, you do not need to perform “Make Edits Compatible” to play in other DVD players.

# Changing the Setup menu

## Tour of the Setup menu

The following table is the contents which you can set and the default settings.  
Refer to the following table for useful operation.

Setup	Items (highlight is the default)	Contents	
1. Language setting ➔ Pages 64-65	Disc Menu Language	English French Spanish ⋮	Set the language for disc menu.
	Audio Language	Original English French ⋮	Set the language for audio.
	Subtitle Language	OFF English French ⋮	Set the language for subtitle.
2. Display setting ➔ Pages 65-66	OSD Language	English Français Español	Set the language for OSD (On Screen Display).
	Angle Icon	ON OFF	Display or undisplay multi-angle icon if DVD in playback mode contains multi-angle scenes.
	Screen Saver	OFF 5 minutes 10 minutes ⋮	Set the time to work the screen saver on the screen.
3. Audio setting ➔ Pages 66-67	Digital Out	PCM 48kHz 96kHz	Set whether the sound recorded in 96kHz will be down sampled in 48kHz.
		Dolby Digital PCM Stream	Set the type of sound signal which outputs from the digital audio output jack.
	Dynamic Range Control	ON OFF	Compressing the range of sound volume.
4. Video setting ➔ Page 68	Progressive Scan	ON OFF	Set to the progressive scan mode (set to "ON") or to the interlace scan mode (set to "OFF").
	Still Mode	Auto Field Frame	Set the type of still image in pausing playback.
5. Parental setting ➔ Pages 69-70	Parental Lock	All level 8 to 1	Set the parental level of your DVD discs.
	(Change password)	Enter the current four-digit password	Set and change the password.
6. PBC setting ➔ Page 70	PBC (Video CD only)	ON OFF	Set the Playback Control. (Video CD only)

### Note

- If you change the setting in the Setup menu, the information of contents stays on even when the power is switched off.
- An item which is not currently available is grayed in the Setup menus.



# Changing the Setup menu

## Language setting

Press [STOP ■] if you are playing a disc.

**1**

Press [SETUP].

**2**

Using [▲ / ▼], select "Playback". Press [OK].

Playback menu will appear.

**3**

Using [▲ / ▼], select "Language". Press [OK].

Language menu will appear.

**4**

Using [▲ / ▼], desired item. Press [OK].

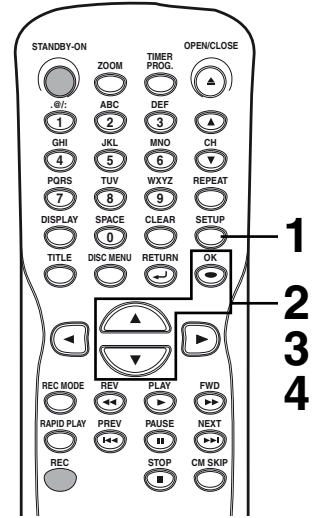

### Disc Menu Language (Default : English)

Set the language for Disc Menu.

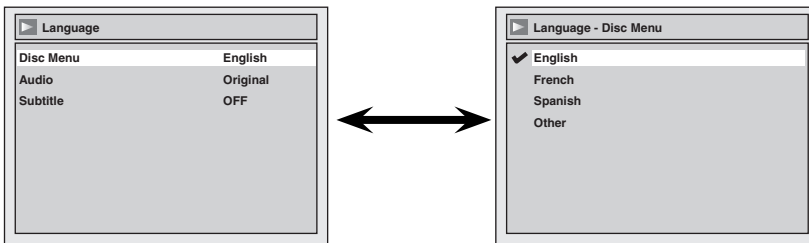

- Using [▲ / ▼], select a setting. Press [OK].  
Your setting will be activated.

### Audio Language (Default : Original)

Set the Audio language.

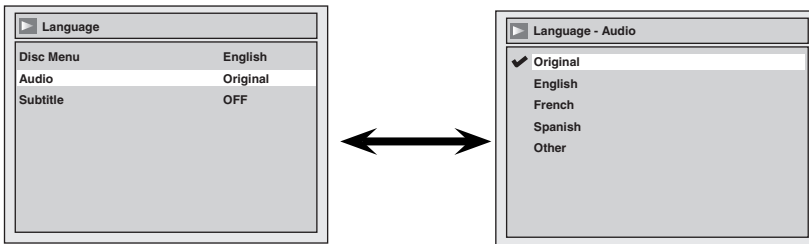

- Using [▲ / ▼], select a setting. Press [OK].  
Your setting will be activated.
- When Original is selected, the audio language will be in the disc's default language.

### Subtitle Language (Default : OFF)

Set the Subtitle language.

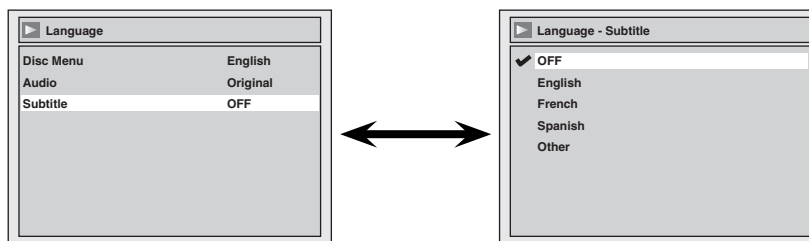

- Using [▲ / ▼], select a setting. Press [OK].  
Your setting will be activated.

# Changing the Setup menu

## Language setting (cont'd)

If "Other" is selected, press 4-digit code using the **Number buttons**.

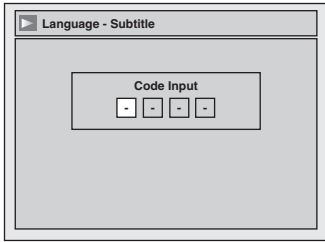

- When you finish entering the code, press [OK]. Refer to the language code table on page 74.

### Note

- Only the languages supported by the disc can be selected.
- Audio Language setting may not be available to some discs.
- You can change or switch off the subtitles on a DVD disc also from the disc menu if it is available.
- Press [CLEAR] or [◀] to erase numbers entered incorrectly.

**5**

Press [SETUP] to exit.

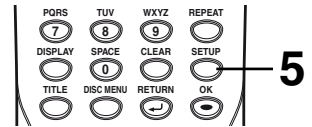

## Display setting

Press [STOP ■] if you are playing a disc.

**1**

Press [SETUP].

**2**

Using [▲ / ▼], select "Display". Press [OK].  
Display menu will appear.

**3**

Using [▲ / ▼], select a desired item. Press [OK].

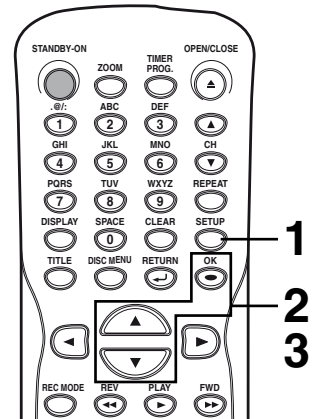

### OSD Language (Default : English)

Set the language for the On Screen display.

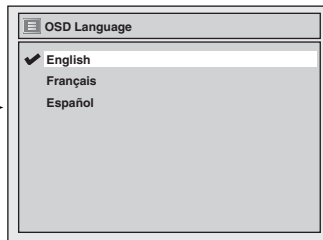
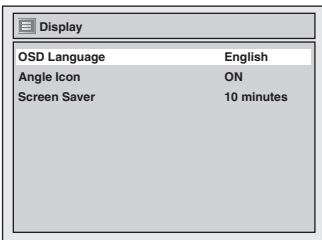

- Using [▲ / ▼], select a setting. Press [OK].  
Your setting will be activated.

### Angle Icon (Default : ON)

Set to "ON" to show the Angle Icon during the playback.

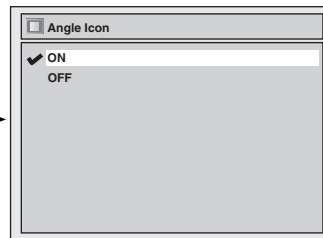
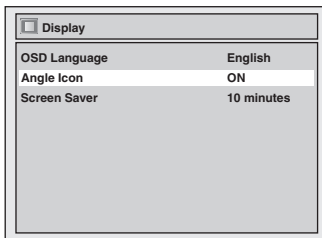

- Using [▲ / ▼], select a setting. Press [OK].  
Your setting will be activated.

Instructions continue on the next page.

# Changing the Setup menu

## Display setting (cont'd)

### Screen Saver (Default : 10 minutes)

Set the time to work the screen saver function on the screen.

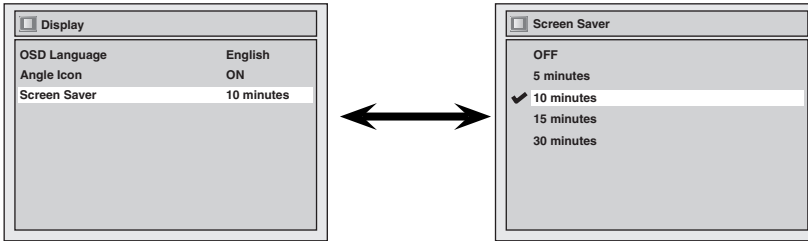

- Using [▲ / ▼], select a setting. Press [OK]. Your setting will be activated.

**4**

Press [SETUP] to exit.

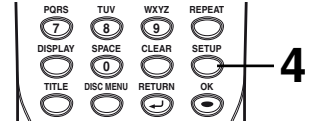

## Audio setting

Choose the appropriate Audio settings for your external equipment.

It will only affect a disc playback.

Press [STOP ■] if you are playing a disc.

**1**

Press [SETUP].

**2**

Using [▲ / ▼], select "Playback". Press [OK]. Playback menu will appear.

**3**

Using [▲ / ▼], select "Disc Audio". Press [OK].

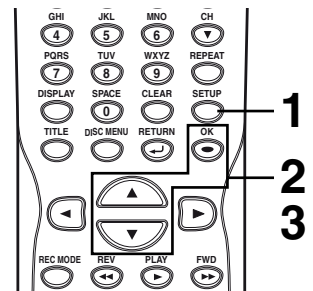

### Note

- Dynamic Range Control function is available only on the discs which are recorded in the Dolby Digital format.

### Digital Out

Set the digital audio output.

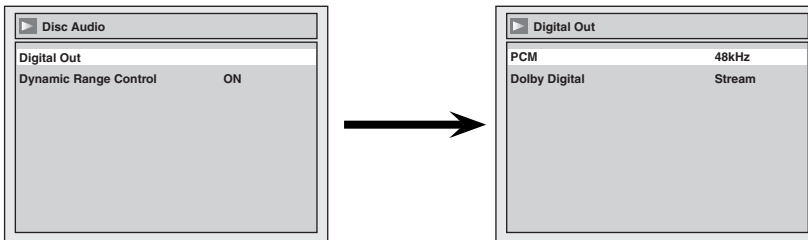

- Using [▲ / ▼], select a setting. Press [OK]. Option window will appear. Proceed to step A or B.

# Changing the Setup menu

## Audio setting (cont'd)

### A Settings for PCM (Default : 48kHz)

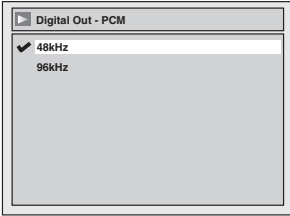

- Using [▲ / ▼], select a setting. Press [OK].

Your setting will be activated.

- 48kHz :If your amplifier/decoder is NOT compatible with 96kHz PCM, select "48kHz". 96kHz sound will be output in 48kHz.
- 96kHz :If your amplifier/decoder is compatible with 96kHz PCM, select "96kHz". 96kHz sound will be output.

#### Note

**When playing disc with copyright protection**

- Even if you select "96kHz", the sound will be down sampled at 48kHz.

### B Settings for Dolby Digital (Default : Stream)

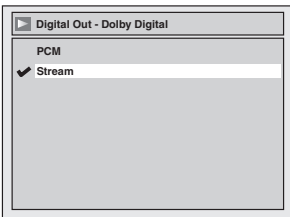

- Using [▲ / ▼], select a setting. Press [OK].

Your setting will be activated.

- PCM :Convert the Dolby Digital into PCM (2 channel).  
When your amplifier/decoder is NOT compatible with Dolby Digital, set to "PCM".
- Stream :Outputs Dolby Digital signals  
When your amplifier/decoder is compatible with Dolby Digital, set to "Stream".

### Dynamic Range Control (Default : ON)

Set to "ON" to compress the range between soft and loud sounds.

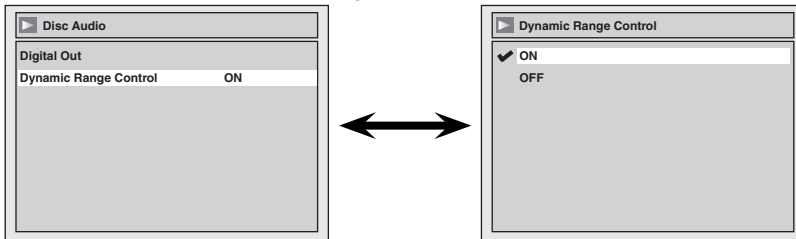

- Using [▲ / ▼], select a setting. Press [OK].

Your setting will be activated.

## 4

Press [SETUP] to exit.

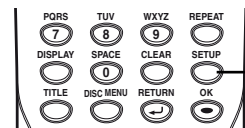

# Changing the Setup menu

## Video setting

### Progressive Scan (Default : OFF)

This unit is compatible with the Progressive Scan System. The feature provides you with the higher definition images than the traditional output system does. To utilize this feature, you must set Progressive Scan mode to "ON".

**1**

Press [SETUP].

**2**

Using [▲ / ▼], select "Playback". Press [OK].

**3**

Using [▲ / ▼], select "Video". Press [OK].

**4**

Using [▲ / ▼], select "Progressive Scan". Press [OK].

**5**

Using [▲ / ▼], select "ON".

Press [OK].

Confirmation window will appear.

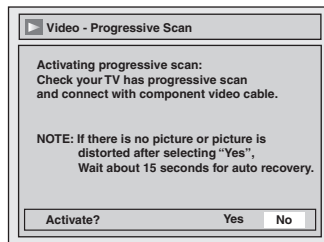

**6**

Using [◀ / ▶], select "Yes". Press [OK].

**7**

Using [▲ / ▼], select "Yes" within 15 seconds. Press [OK].

Your setting will be activated.

**8**

Press [SETUP] to exit.

### Still Mode (Default : Auto)

Select "Auto" usually.

Press [STOP ■] if you are playing a disc.

**1**

Proceed to steps 1 to 3 above.

**2**

Using [▲ / ▼], select "Still Mode". Press [OK].

**3**

Using [▲ / ▼], select a setting. Press [OK].

Your setting will be activated.

Auto: Optimum resolution setting (Field or Frame) will be selected.

Field: Images in the still mode will be stabilized.

Frame: Images in the still mode will be highly defined.

**4**

Press [SETUP] to exit.

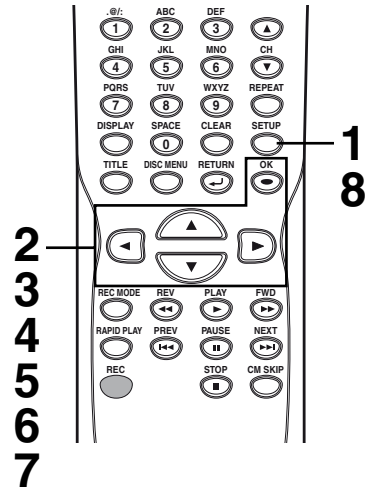

#### Note

- If your TV is compatible with Progressive Scan (525p / 480p), you must use the Component video cable (commercially available) to connect this unit to the TV. (See Method 2 on page 13.) If not, use the video cable and set the Progressive Scan to "OFF" or press and hold [SETUP] for more than 3 seconds during DVD playback.
- When selecting "No" or not pressing any keys on the unit or remote control within 15 seconds at step 7, Progressive Scan remains to be "OFF" (interlace scan).

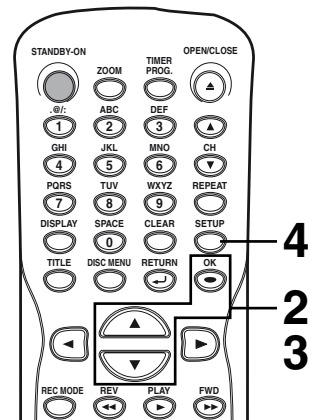

#### Note

- Frame is 1 completed video image made up of 2 fields (There are 30 frame per second of NTSC video).

# Changing the Setup menu

## Settings for Parental lock level

Some DVD-Video discs feature a Parental Lock level. Playback will stop if the ratings exceed the levels you set, it will require you to enter a password before the disc will playback. This feature prevents your children from viewing inappropriate material.

Press [STOP ■] if you are playing a disc.

**1**

Press [SETUP].

**2**

Using [▲ / ▼], select "Playback". Press [OK].  
Playback menu will appear.

**3**

Using [▲ / ▼], select "Parental Lock". Press [OK].

**4**

Using [▲ / ▼], select the desired level. Press [OK].

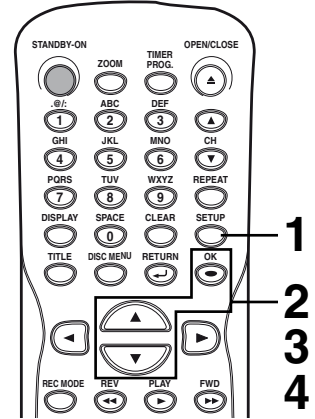

### Note

- Parental lock function may not be available to some discs.
- With some DVDs, it may be difficult to find if they are compatible with parental lock. Be sure to check if the parental lock function operates in the way that you have set.
- Record the password in case you forget it.

### Parental Lock (Default : All)

Set the Parental Lock level.

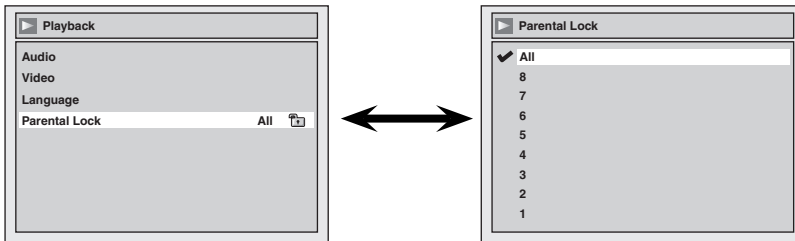

- Using [▲ / ▼], change the parental level. Press [OK].  
Option window will appear  
Proceed to step A or B.

**A** A password has not been set yet.

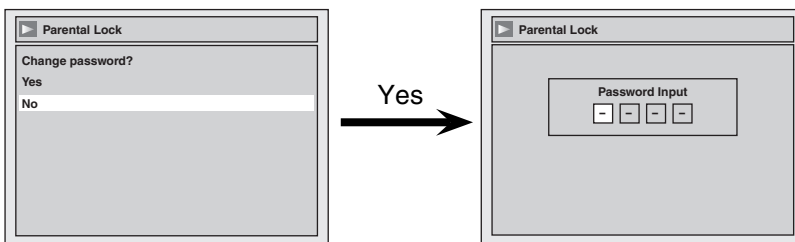

- Using [▲ / ▼], select "Yes". Press [OK].
- If you select "No", proceed to step 5.
- Using the Number buttons, enter a new password. Press [OK].  
Your setting will be activated.

Instructions continue on the next page.

# Changing the Setup menu

## Settings for Parental lock level (cont'd)

**B**  A password has been set already.

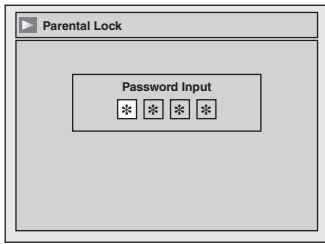

- Using the Number buttons, enter the current password.

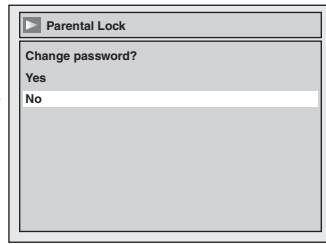

- Using [▲ / ▼], select “Yes”. Press [OK].
- If you select “No”, proceed to step 5.



<Change the password>

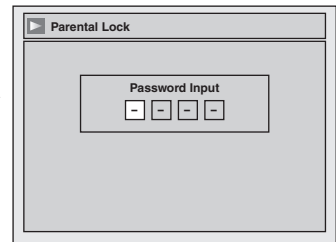

- Using the Number buttons, enter a new password. Press [OK]. Your setting will be activated.

### 5

Press [SETUP] to exit.

#### Note

- Press [CLEAR] to erase numbers entered incorrectly.
- When you forget the password or you want to clear all settings in Parental lock, enter 4,7,3,7 using the Number buttons in Password Input window. Password will be cleared and parental levels will be set to “All”.

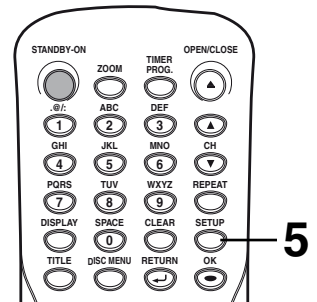

## Settings for PBC (Playback Control)

### PBC (Video CD only) (Default : ON)

You can select images or information on the menu screen by activating PBC (Playback Control) function of Video CD.

Press [STOP ■] if you are playing a disc.

### 1

Press [SETUP].

### 2

Using [▲ / ▼], select “CD Playback Mode”. Press [OK]. CD Playback menu will appear.

### 3

Using [▲ / ▼], select “PBC (Video CD only)”. Press [OK].

### 4

Using [▲ / ▼], select “ON” or “OFF”. Press [OK]. Your setting will be activated.

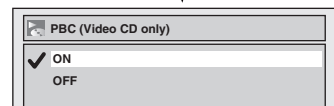
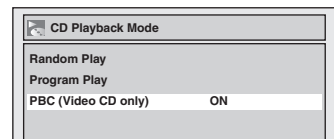

#### Note

- When playing Video CDs with PBC function, some operations (e.g. select and track repeat) cannot be performed. Select PBC function “OFF” to perform those operations.
- PBC setting turns to “ON” when loading Video CDs with PBC function, thus, even after setting PBC to “OFF” and ejecting the Video CD then reloading the Video CD, this setting turns to “ON” automatically.



## Troubleshooting

Before requesting service for this unit, check the table below for a possible cause of the problem you are experiencing. Some simple checks or a minor adjustment on your part may eliminate the problem and restore proper operation.

Symptom	Remedy
<b>Power</b>	
The power does not turn on.	<ul style="list-style-type: none"> <li>• Check that the AC power cord is connected securely.</li> <li>• (In case of power failure) Check the breaker.</li> </ul>
<b>Picture</b>	
There is no picture.	<ul style="list-style-type: none"> <li>• Re-connect the connecting cords securely.</li> <li>• Check if the connecting cords are damaged.</li> <li>• If Setup menu appears on the TV screen, press [RETURN ↵] to exit.</li> <li>• Check the connection to your TV (page 13).</li> <li>• Check if the Progressive Scan mode is set correctly according to your TV (page 68).</li> <li>• Switch the input selector on your TV (such as to "EXT1") so that the signal from the unit appears on the TV screen.</li> </ul>
Picture noise appears.	<ul style="list-style-type: none"> <li>• The disc is dirty or flawed.</li> <li>• If the picture output signal from the unit passes through your VCR to get to your TV, or if you are connected to a combination TV/VIDEO player, the copy-protection signal applied to some DVD programs could affect picture quality. If you still experience this problem even when you connect the unit directly to your TV, try connecting the unit to your TV's S-VIDEO input.</li> </ul>
TV program reception does not fill the screen.	<ul style="list-style-type: none"> <li>• Try to set the channels with "Auto Channel Preset" or "Manual Channel Preset" in the Setup menu (pages 18-19).</li> <li>• Select a channel of any TV program using [CH ▲ / ▼].</li> </ul>
TV program pictures are distorted.	<ul style="list-style-type: none"> <li>• Adjust TV antenna.</li> <li>• Adjust the picture (see the TV's instruction manual).</li> <li>• Place the unit and TV farther apart.</li> <li>• Place the TV and any bunched antenna cables farther apart.</li> </ul>
TV channels cannot be changed.	<ul style="list-style-type: none"> <li>• Switch the input to TV.</li> <li>• Connect the antenna cable correctly (page 13).</li> </ul>
Playback picture is distorted.	<ul style="list-style-type: none"> <li>• Keep the equipment which may cause electrical disturbances, such as a cellular phone, away.</li> </ul>
The playback picture or TV program from the equipment connected through the unit is distorted.	<ul style="list-style-type: none"> <li>• If the playback picture output from a DVD player, VCR or tuner goes through the unit before reaching your TV, the copy-protection signal applied to some programs could affect picture quality. Disconnect the playback equipment in question and connect it directly to your TV.</li> </ul>
<b>Sound</b>	
There is no sound.	<ul style="list-style-type: none"> <li>• The disc is dirty or flawed.</li> <li>• Re-connect all connections securely.</li> <li>• Check if the connecting cord is damaged.</li> <li>• Check the connections to the amplifier input.</li> <li>• The input source setting on the amplifier is incorrect.</li> <li>• The recorder is in pause mode or in Slow-motion Play mode.</li> <li>• The recorder is in fast forward or fast reverse mode.</li> <li>• If the audio signal does not come through the DIGITAL AUDIO OUTPUT (COAXIAL) jack, check the Audio settings (pages 66-67).</li> </ul>
Sound is noisy.	<ul style="list-style-type: none"> <li>• The disc is dirty or flawed.</li> </ul>
No DTS sound is output.	<ul style="list-style-type: none"> <li>• This unit is not compatible with DTS sound.</li> </ul>
<b>Remote control</b>	
The remote control does not function.	<ul style="list-style-type: none"> <li>• Batteries are weak.</li> <li>• There are obstacles between the remote control and the unit.</li> <li>• The remote control is far from the unit.</li> <li>• There are no batteries in the remote control.</li> <li>• Turn on the unit.</li> <li>• The remote control is not pointed at the remote sensor on the unit.</li> </ul>

• If above remedies do not solve the problem, please call the Authorized Service Center for help.

# Others

## Troubleshooting (cont'd)

Symptom	Remedy
<b>Playback</b>	
The disc does not play.	<ul style="list-style-type: none"> <li>• No disc is inserted.</li> <li>• A blank disc is inserted.</li> <li>• The disc is upside down. Insert the disc with the labeled side facing up.</li> <li>• The disc is not correctly inserted.</li> <li>• The unit cannot play certain discs (such as a CD-ROM) (page 38).</li> <li>• The region code on the DVD-Video does not match the unit (page 38).</li> <li>• Moisture has condensed inside the unit. Remove the disc and leave the unit turned on for about two hours until the moisture evaporates (page 4).</li> <li>• If the disc was recorded on another recorder, the unit cannot play the disc if it was not finalized.</li> </ul>
Playback image freezes for a second.	<ul style="list-style-type: none"> <li>• During the playback of two layered disc, picture may freeze for a moment when the 1st layer switches to the 2nd layer. This is not a malfunction.</li> </ul>
The disc does not start playback from the beginning.	<ul style="list-style-type: none"> <li>• Resume play was activated (page 42). Press <b>[STOP ■]</b> twice.</li> <li>• You have inserted a disc whose Title menu or DVD menu automatically appears on the TV screen when it is first insert.</li> </ul>
The unit starts playing from the disc automatically.	<ul style="list-style-type: none"> <li>• The DVD-Video features an auto playback function.</li> </ul>
Some functions such as Stop, Search, or Slow-motion Play cannot be performed.	<ul style="list-style-type: none"> <li>• Depending on the disc, you may not be able to do some of the operations. See the instruction manual supplied with the disc.</li> </ul>
The language for the sound track cannot be changed.	<ul style="list-style-type: none"> <li>• Multilingual tracks are not recorded being played.</li> <li>• The DVD-Video prohibits the changing of the language for the sound track.</li> <li>• Try changing the language using the DVD-Video's menu.</li> </ul>
The subtitle language cannot be changed or turned off.	<ul style="list-style-type: none"> <li>• Multilingual subtitle are not recorded on the DVD-Video.</li> <li>• The DVD-Video prohibits changing of the subtitles.</li> <li>• Try changing the subtitle using the DVD-Video's menu.</li> </ul>
The angles cannot be changed.	<ul style="list-style-type: none"> <li>• Multi-angles are not recorded on the DVD-Video being played.</li> <li>• The angle-change operation is whenever possible as long as the disc contains a multi-angle portion. Actual change will be performed when the portion has come up.</li> <li>• The DVD-Video prohibits changing angles.</li> <li>• Try changing the angle using the DVD-Video's menu.</li> </ul>
<b>Recording/Timer Recording/Editing</b>	
The channel cannot be changed from the channel you are recording.	<ul style="list-style-type: none"> <li>• Set the TV's input to "TV."</li> </ul>
Recording does not start immediately after you press <b>[RECORD]</b> or <b>[REC]</b> .	<ul style="list-style-type: none"> <li>• A brand-new DVD+RW or DVD-RW has been inserted. It takes a while for the unit to automatically format a DVD+RW/-RW.</li> </ul>
Nothing was recorded even though you set the timer setting correctly.	<ul style="list-style-type: none"> <li>• There was a power failure during recording.</li> <li>• The unit's internal clock stopped due to a power failure that lasted for more than 30 seconds. Reset the clock (pages 21- 23).</li> <li>• Disconnect the AC power cord from the AC outlet, and connect it again.</li> <li>• The program contains copy protection signals that restricts copying.</li> <li>• The timer setting overlapped with another setting that has priority.</li> </ul>
Recording does not stop immediately after you press <b>[STOP ■]</b> .	<ul style="list-style-type: none"> <li>• It will take a few seconds for the unit to input disc data before recording can stop.</li> </ul>
Timer Recording is not complete or did not start from the beginning.	<ul style="list-style-type: none"> <li>• The timer setting overlapped with another setting that has priority (page 31).</li> <li>• Disc space was not enough.</li> </ul>

## Troubleshooting (cont'd)

Symptom	Remedy
---------	--------

### Others

The unit does not operate properly.

- When static electricity, etc., causes the unit to operate abnormally, unplug the unit and then plug it in again.

The disc tray does not open when you press [OPEN/CLOSE ▲].

- It may take a few seconds for the disc tray to open after you have recorded or edited a disc.
- This is because the unit is adding disc data to the disc.

“Repairing” appears on the TV screen.

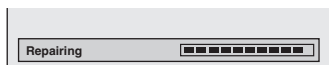

In a case you intend to cancel the Repairing process.

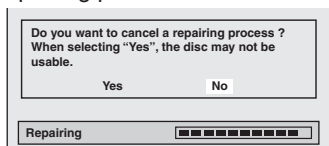

- If there is a power failure or unplugging during recording, finalizing, formatting or editing (even after “Repairing” disappears), a Repairing process will begin automatically just after turning the unit on again. It may take several minutes up to about several hours.
- If you intend to cancel the Repairing process, press [OPEN/CLOSE ▲] on the front panel, then select “Yes” and press [OK]. After that, press [OPEN/CLOSE ▲] to take out the disc. **The disc canceled the Repairing process MAY NOT work.**

Error message	Cause	Solution
<p><b>Disc Error</b></p> <p>--- Please eject the disc. --- Playback feature may not be available on this Disc.</p>	<ul style="list-style-type: none"> <li>• Unplayable disc is inserted in the unit.</li> <li>• The disc is upside down.</li> </ul>	<ul style="list-style-type: none"> <li>• Insert the standardized disc which bear the marks on page 38.</li> <li>• Insert the disc with the labeled side facing up.</li> </ul>
<p><b>Region Error</b></p> <p>--- Please eject the disc. --- Playback is not authorized in your region.</p>	<ul style="list-style-type: none"> <li>• Playback is not authorized in the region of the DVD-Video disc which you inserted in the unit.</li> </ul>	<ul style="list-style-type: none"> <li>• Insert the DVD-Video disc with region codes 1 or ALL.</li> </ul>
<p><b>Parental Lock On</b></p> <p>The current selected parental level prohibits playback.</p>	<ul style="list-style-type: none"> <li>• The current selected parental level in the SETUP Menu prohibits playback.</li> </ul>	<ul style="list-style-type: none"> <li>• Check the “Parental Lock” setting (pages 69-70).</li> </ul>
<p><b>Recording Error</b></p> <p>This program is not allowed to be recorded.</p>	<ul style="list-style-type: none"> <li>• The recording function encountered the copy prohibited program.</li> </ul>	<ul style="list-style-type: none"> <li>• You cannot record copy prohibited programs.</li> </ul>
<p><b>Recording Error</b></p> <p>This program is not recordable in +VR mode.</p>	<ul style="list-style-type: none"> <li>• You are trying to record the copy-once program.</li> </ul>	<ul style="list-style-type: none"> <li>• You cannot record the copy-once program.</li> </ul>
<p><b>Recording Error</b></p> <p>Can not record on this disc.</p>	<ul style="list-style-type: none"> <li>• You are trying to record onto the disc which is unrecordable, or the disc status is unable to record.</li> <li>• The disc is dirty.</li> <li>• The disc is damaged.</li> </ul>	<ul style="list-style-type: none"> <li>• Insert the recordable disc, and ensure the disc status satisfies the recording requirements (page 24).</li> <li>• Clean the disc with a cleaning cloth.</li> <li>• Replace the disc.</li> </ul>
<p><b>Recording Error</b></p> <p>This disc is protected and not recordable.</p>	<ul style="list-style-type: none"> <li>• You are trying to record on to the protected disc which is set in the Disc Edit menu.</li> </ul>	<ul style="list-style-type: none"> <li>• Release the disc protect setting in the Disc Edit menu (page 35).</li> </ul>
<p><b>Recording Error</b></p> <p>Disc is full. (No area for new recording)</p>	<ul style="list-style-type: none"> <li>• You are trying to record onto the disc which has no space for recording.</li> </ul>	<ul style="list-style-type: none"> <li>• Insert the recordable disc with enough recording space.</li> </ul>
<p><b>Recording Error</b></p> <p>You cannot record more than 49 titles on one disc. (The maximum is 49)</p>	<p>You are trying to record onto the disc on which the number of recording titles comes up to the maximum (49).</p>	<p>Delete unnecessary titles (page 52).</p>

# Others

## Troubleshooting (cont'd)

Error message	Cause	Solution
<b>Recording Error</b> You cannot record more than 254 chapters on one disc. (The maximum is 254)	You are trying to record onto the VR mode DVD-RW disc on which the number of recording chapters comes up to the maximum (254).	Delete unnecessary chapter marks (pages 54-55).
<b>Recording Error</b> You cannot record on this disc as Power Calibration Area is full.	When recordings are performed repeatedly onto an unstable disc, this area may come up to be full.  Every time you insert a disc for recording, the disc's working area will be taken up. And if you repeat this frequently, it will be used up sooner and you may not be able to record full 49 titles.	Insert a new disc.
<b>Recording Error</b> This disc is already finalized.	You are trying to record onto the disc already finalized.	Release the finalizing for this disc (page 36).
<b>Recording Error</b> The disc has a different menu layout. (Set "Replace Disc Menu" to ON to rewrite the menu.)	You are trying to record onto the +VR formatting disc that had been recorded by the other recorder.	Set "Replace Disc Menu" to "ON" to rewrite the menu, after that you will record to disc (page 26).

\* If you are still having trouble with the unit after checking "Troubleshooting", write down the error code and the error description for calling our help line mentioned on the front page to locate an Authorized Service Center.

## Language code

Language	Code	Language	Code	Language	Code	Language	Code
Abkhazian	4748	French	5264	Lithuanian	5866	Sindhi	6550
Afar	4747	Frisian	5271	Macedonian	5957	Singhalese	6555
Afrikaans	4752	Galician	5358	Malagasy	5953	Siswat	6565
Albanian	6563	Georgian	5747	Malay	5965	Slovak	6557
Amharic	4759	German	5051	Malayalam	5958	Slovenian	6558
Arabic	4764	Greek	5158	Maltese	5966	Somali	6561
Armenian	5471	Greenlandic	5758	Maori	5955	Spanish	5165
Assamese	4765	Guarani	5360	Marathi	5964	Sundanese	6567
Aymara	4771	Gujarati	5367	Moldavian	5961	Swahili	6569
Azerbaijani	4772	Hausa	5447	Mongolian	5960	Swedish	6568
Bashkir	4847	Hebrew	5569	Nauru	6047	Tagalog	6658
Basque	5167	Hindi	5455	Nepali	6051	Tajik	6653
Bengali; Bangla	4860	Hungarian	5467	Norwegian	6061	Tamil	6647
Bhutani	5072	Icelandic	5565	Occitan	6149	Tatar	6666
Bihari	4854	Indonesian	5560	Oriya	6164	Telugu	6651
Bislama	4855	Interlingua	5547	Oromo (Afan)	6159	Thai	6654
Breton	4864	Interlingue	5551	Panjabi	6247	Tibetan	4861
Bulgarian	4853	Inupiak	5557	Pashto; Pushto	6265	Tigrinya	6655
Burmese	5971	Irish	5347	Persian	5247	Tonga	6661
Byelorussian	4851	Italian	5566	Polish	6258	Tsonga	6665
Cambodian	5759	Japanese	5647	Portuguese	6266	Turkish	6664
Catalan	4947	Javanese	5669	Quechua	6367	Turkmen	6657
Chinese	7254	Kannada	5760	Rhaeto-Romance	6459	Twi	6669
Corsican	4961	Kashmiri	5765	Romanian	6461	Ukrainian	6757
Croatian	5464	Kazakh	5757	Russian	6467	Urdu	6764
Czech	4965	Kinyarwanda	6469	Samoan	6559	Uzbek	6772
Danish	5047	Kirghiz	5771	Sangho	6553	Vietnamese	6855
Dutch	6058	Kirundi	6460	Sanskrit	6547	Volapuk	6861
English	5160	Korean	5761	Scots Gaelic	5350	Welsh	4971
Esperanto	5161	Kurdish	5767	Serbian	6564	Wolof	6961
Estonian	5166	Laothian	5861	Serbo-Croatian	6554	Xhosa	7054
Faroese	5261	Latin	5847	Sesotho	6566	Yiddish	5655
Fiji	5256	Latvian; Lettish	5868	Setswana	6660	Yoruba	7161
Finnish	5255	Lingala	5860	Shona	6560	Zulu	7267

**Analog audio**

An electrical signal that directly represents sound. Compare this to digital audio which can be an electrical signal, but is an indirect representation of sound. See also Digital audio.

**Aspect ratio**

The width of a TV screen relative to its height. Conventional TVs are 4:3 (in other words, the screen is almost square); widescreen models are 16:9 (the screen is almost twice as wide as it is high).

**Chapter**

Just as a book is split up into several chapters, a title on a DVD disc is usually divided into chapters. See also Title.

**Component video output**

Each signal of luminance (Y) and component (P<sub>B</sub>/C<sub>B</sub>, P<sub>R</sub>/C<sub>R</sub>) is independent to output so that you can experience picture color as it is. Also, due to compatibility with progressive video (525p/480p), you can experience higher-density picture than that in interlace (525i/480i).

**Digital audio**

An indirect representation of sound by numbers. During recording, the sound is measured at discrete intervals (44,100 times a second for CD audio) by an analog-to-digital converter, generating a stream of numbers. On playback, a digital-to-analog converter generates an analog signal based on these numbers. See also Sampling frequency and Analog audio.

**Dolby Digital**

The system to compress digital sound developed by Dolby Laboratories. It offers you sound of stereo(2ch) or Multi-channel audio.

**Finalize**

To make DVD discs, which have been recorded on, possible to play in DVD players. With this unit, it is possible to finalize DVD-RW/ DVD-R/DVD+R/discs.

**MP3 (MPEG Audio Layer 3)**

MP3 is a method of compressing files. You can copy MP3 files on CD-RW/R discs from the computer and play the files on this unit.

**PBC (Playback Control) (Video CD only)**

This function enables you to play back interactive software using a menu screen. See also Video CD.

**PCM (Pulse Code Modulation)**

The most common system of encoding digital audio, found on CDs and DAT. Excellent quality, but requires a lot of data compared to formats such as Dolby Digital and MPEG audio. For compatibility with digital audio recorders (CD, MD and DAT) and AV amplifiers with digital inputs, this unit can convert Dolby Digital and MPEG audio to PCM. See also Digital audio.

**Progressive Scan (525p/480p)**

A type of display that does not split each frame into fields, and instead scans directly through all the scanlines of each frame in order. Progressive Scan provides less flickering and higher image resolution than traditional (525i/480i) TV signals. Refer to page 68 for instructions on selective Progressive Scan mode.

**Regions code**

Regions associate discs and players with particular areas of the world. This unit will only play discs that have compatible region codes. You can find the region code of your unit by looking on the rear panel. Some discs are compatible with more than one region (or all regions).

**Sampling frequency**

The rate which sound is measured by a specified interval to turn into digital audio data. The numbers of sampling in one second defines as sampling frequency. The higher the rate, the better the sound quality as possible as it is.

**SAP (Secondary Audio Program)**

Sub-audio channel which is delivered separately from main-audio channel. This audio channel is used as an alternate in bilingual broadcasting.

**S-Video output**

It delivers independently each signal of color(C) and luminance(Y) to TV as video signals, so that higher-quality picture will be gained.

**Title (DVD only)**

A collection of chapters on DVD disc. See also chapter.

**Track**

Audio CDs use tracks to divide up the content of a disc. The DVD equivalent is called a chapter. See also Chapter.

**Video CD**

The contents of a Video CD. When playing back a Video CD with the PBC function, the title menu will appear automatically.

**Frequently Asked Questions**

- Can I record to CD-RW/R?  
No, this unit records only DVDs.
- Can I play DVD-Video that is bought in another country?  
Possible when the region code of the disc is 1 and All.
- Is this unit JPEG compatible?  
No.
- Can I connect the unit to my PC?  
No, you cannot control the unit by PCs.

# Others

## Specifications

### General

System	DVD-Video, DVD+RW/R, DVD-RW/R, CD-DA, CD-RW/R
Power requirements	AC120 V, 60 Hz
Power consumption	20 W (standby: 1.6 W)
Weight	5.06 lbs ( 2.3 kg )
Dimensions (width x height x depth)	17 3/16" x 2 5/8" x 9 5/8" (435 x 66 x 244 mm)
Operating temperature	41F° to 104F° (5°C to 40°C)
Operating humidity	Less than 80% (no condensation)
TV format	NTSC

### Recording

Recording format	DVD+VR format
Recordable discs	DVD+Rewritable, DVD+Recordable DVD-Rewritable, DVD-Recordable (+VR mode only)

### Video recording format

Sampling frequency	13.5MHz
Compression format	MPEG

### Audio recording format

Sampling frequency	48kHz
Compression format	Dolby Digital

### Tuner

#### Receivable channels

VHF	2-13ch
UHF	14-69ch
CATV	C1-C125ch

### Input/Output

VHF/UHF antenna input/output terminal	VHF/UHF set 75Ω
<b>Video input</b>	Input 1 (rear), 2 (front)
Input level	1 Vp-p (75Ω)
Jacks	RCA jack
<b>Video output</b>	Output 1 (rear)
Output level	1 Vp-p (75Ω)
Jack	RCA jack
<b>S-Video input</b>	Input 1 (rear), 2 (front)
Y (luminance) - Input level	1 Vp-p (75Ω)
C (color) - Input level	286 mVp-p (75Ω)
Jacks	4 pin mini DIN
<b>S-Video output</b>	Output 1 (rear)
Y (luminance) - Output level	1 Vp-p (75Ω)
C (color) - Output level	286 mVp-p (75Ω)
Jack	4 pin mini DIN
<b>Component video output</b>	Output 1 (rear)
Output level	Y: 1.0 Vp-p (75Ω), Pb/Cb, Pr/Cr: 0.7 Vp-p (75Ω)
Jacks	RCA jacks
<b>Audio input</b>	Input 1 (rear), 2 (front) L/R
During audio input	2V rms (Input impedance: more than 22kΩ)
Jacks	RCA jacks
<b>Audio output</b>	Output 1 L/R (rear)
During audio output	2V rms (Output impedance: less than 1kΩ)
Jacks	RCA jacks
<b>Digital audio output</b>	Output 1 (rear) COAXIAL
Output level	500 mVp-p (75Ω)
Jack	RCA jack

### Note:

The specifications and design of this product are subject to change without notice.

## Fácil grabación de DVD

Estas instrucciones le ayudarán a entender fácilmente cómo grabar discos DVD.

### Nota:

Asegúrese que las pilas están en el mando a distancia y que ha conectado correctamente esta unidad y el TV.

### Paso 1: Elija un tipo de disco.

Puede elegir entre distintos tipos de discos DVD grabables. Este grabador de DVD puede grabar los siguientes tipos de discos.



Por ejemplo, cuando desea grabar repetidamente en el mismo disco, seleccione el disco de tipo regrabable DVD+RW/DVD-RW.

Cuando desea guardar grabaciones sin alterarlos, un DVD no regrabable DVD+R/DVD-R puede ser más conveniente.

### Paso 2: Encienda la unidad.

Mando a distancia

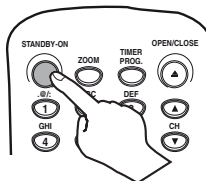

Seleccione la entrada a la que se conectará la unidad en su TV.

### Paso 3: Coloque un disco en blanco.

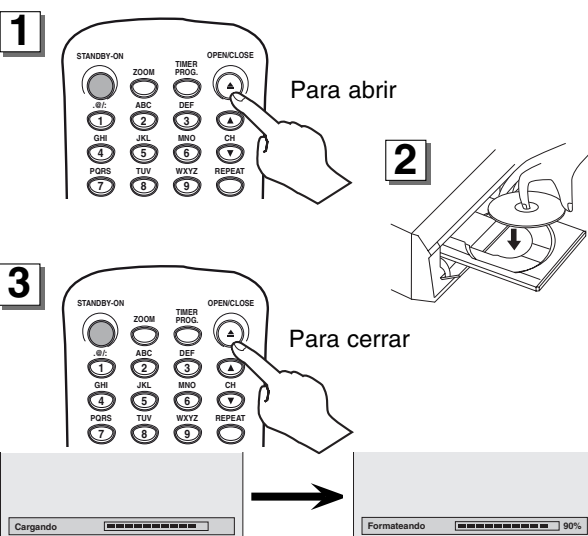

DVD+RW/DVD-RW solamente

Esta operación puede demorar en reconocerse.

### Paso 4: Seleccione la velocidad de grabación.

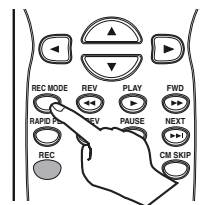



### Paso 5: Eleccione el canal deseado.

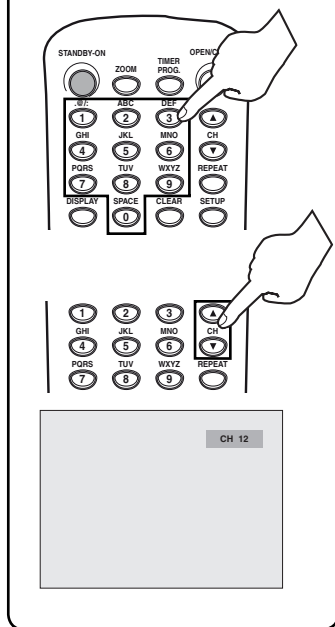

### Paso 6: Grabe en discos DVD.

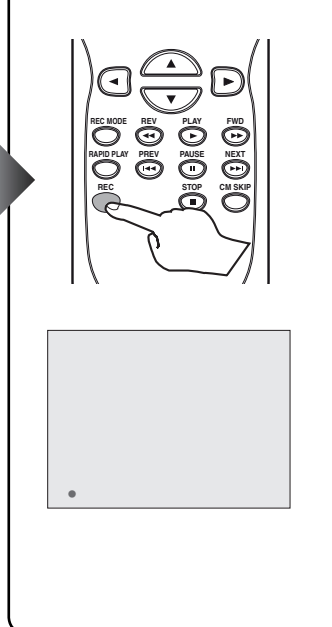

### Paso 7: Pare la grabación.

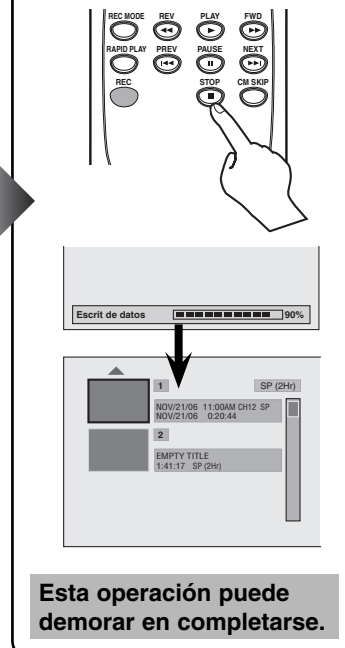

Esta operación puede demorar en completarse.

### Sugerencia 1: Reproduzca el contenido grabado

Puede seleccionar el título que desea reproducir de un menú indicado y empiece a reproducir inmediatamente. El contenido grabado se puede acceder fácilmente con un simple procedimiento de elegir un título en la pantalla del menú.

#### ¿Qué son títulos y capítulos?

El contenido de un disco DVD se divide generalmente en títulos. Los títulos pueden dividirse a su vez en capítulos.

### Sugerencia 2: Edite el disco grabado

La edición de discos es fácil. Esta unidad ofrece convenientes funciones de edición para discos formateados en el modo DVD+VR.

**Puede editar lo siguiente desde el menú del título o el menú de ajuste.**

- Borrado de títulos
- Poniendo nombres en títulos
- Seleccionando/borrando marcas de capítulos
- Ocultando capítulos
- Seleccionando imágenes para índices
- División de un título (DVD+RW/DVD-RW solamente)
- Poniendo un nombre en disco

#### Finalización de un disco

- Esto permitirá que un disco DVD+R/DVD-RW/DVD-R que se grabe en nuestra unidad pueda ser reproducido en un reproductor DVD diferente. **Un disco sin finalizar no se podrá reproducir en otro reproductor.**
- Después de finalizar un disco, no puede editar los contenidos en ese disco.
- Los discos DVD+RW no requieren finalización, pero sí "Compatibilizar edic." para reproducirse en otras unidades después de ediciones. Puede editar el disco después de "Compatibilizar edic."

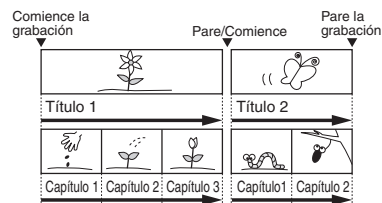

# MEMO

A series of horizontal dotted lines for writing.



## LIMITED WARRANTY

FUNAI CORP. will repair this product, free of charge in the USA in the event of defect in materials or workmanship as follows:

### DURATION:

**PARTS:** FUNAI CORP. will provide parts to replace defective parts without charge for one (1) year from the date of original retail purchase. Certain parts are excluded from this warranty.

**LABOR:** FUNAI CORP. will provide the labor without charge for a period of ninety (90) days from the date of original retail purchase.

### LIMITS AND EXCLUSIONS:

This warranty is extended only to the original retail purchaser. A purchase receipt or other proof of original retail purchase will be required together with the product to obtain service under this warranty.

This warranty shall not be extended to any other person or transferee.

This warranty is void and of no effect if any serial numbers on the product are altered, replaced, defaced, missing or if service was attempted by an unauthorized service center. This limited warranty does not apply to any product not purchased and used in the United States.

This product is produced for home use and this warranty only covers failures due to defects in material or workmanship which occurs during normal use. It does not cover damage which occurs in shipment, or failures which are caused by repairs, alterations or product not supplied by FUNAI CORP., or damage which results from accident, misuse, abuse, mishandling, misapplication, alteration, faulty installation, improper maintenance, commercial use such as hotel, rental or office use of this product or damage which results from fire, flood, lightning or other acts of God.

THIS WARRANTY DOES NOT COVER PACKING MATERIALS, ANY ACCESSORIES (EXCEPT REMOTE CONTROL), ANY COSMETIC PARTS, COMPLETE ASSEMBLY PARTS, DEMO OR FLOOR MODELS.

FUNAI CORP. AND ITS REPRESENTATIVES OR AGENTS SHALL IN NO EVENT BE LIABLE FOR ANY GENERAL, INDIRECT OR CONSEQUENTIAL DAMAGES ARISING OUT OF OR OCCASIONED BY THE USE OF OR THE INABILITY TO USE THIS PRODUCT. THIS WARRANTY IS MADE IN LIEU OF ALL OTHER WARRANTIES, EXPRESS OR IMPLIED, AND OF ALL OTHER LIABILITIES ON THE PART OF FUNAI, ALL OTHER WARRANTIES INCLUDING THE WARRANTY OF MERCHANTABILITY, AND FITNESS FOR A PARTICULAR PURPOSE, ARE HEREBY DISCLAIMED BY FUNAI AND ITS REPRESENTATIVES IN THE UNITED STATES. ALL WARRANTY INSPECTIONS AND REPAIRS MUST BE PERFORMED BY AN AUTHORIZED SERVICE CENTER. THIS WARRANTY IS VALID WHEN THE UNIT IS CARRIED-IN TO AN AUTHORIZED SERVICE CENTER.

### IMPORTANT:

THIS LIMITED WARRANTY GIVES YOU SPECIFIC LEGAL RIGHTS. YOU MAY HAVE OTHER RIGHTS THAT VARY FROM STATE TO STATE. IF, AT ANY TIME DURING THE WARRANTY PERIOD, YOU ARE UNABLE TO OBTAIN SATISFACTION WITH THE REPAIR OF THIS PRODUCT, PLEASE CONTACT FUNAI CORP.

### ATTENTION:

FUNAI CORP. RESERVES THE RIGHT TO MODIFY ANY DESIGN OF THIS PRODUCT WITHOUT PRIOR NOTICE.

### WARRANTY STATEMENT REGARDING NON AUTHORIZED REPAIRS:

To obtain warranty service, you must take the product, or deliver the product freight prepaid, in either its original packaging or packaging affording an equal degree of protection, to any AUTHORIZED SERVICE CENTER. FUNAI CORP. will not reimburse you for any service done by unauthorized service providers without prior written approval.

**To locate your nearest AUTHORIZED SERVICE CENTER or for general service inquiries, please contact us at:**

**FUNAI CORPORATION**  
Customer Service

**Tel :1-800-518-1180**

**<http://www.funai-corp.com>**

19900 Van Ness Avenue, Torrance, CA 90501

# Quick Guide

## DVD Recorder WV10D6

### Playable discs

This unit is compatible to play the following discs.

Disc	Logo	Disc	Logo
DVD-VIDEO		DVD-R (VIDEO mode, Finalized)	
DVD+RW		CD-DA (AUDIO CD)	
DVD+R		Video CD	
DVD+R Double Layer		CD-RW (CD-DA FORMAT, MP3 files)	
DVD-RW (VIDEO mode, Finalized)		CD-R (CD-DA FORMAT, MP3 files)	

is a trademark of DVD Format/Logo Licensing Corporation.

### Region codes



The number inside the globe refers to region of the world.  
This unit can play DVDs that are labeled for ALL regions or for Region 1.

### Recordable discs

This unit can record to the following disc types.

- This unit automatically records in +VR mode.
- DVD+R/DVD-R discs can only be recorded to once. DVD+RW/DVD-RW discs can be recorded to and erased many times.
- Discs that have been tested and are proven to be compatible with this recorder:  
VERBATIM DVD+R 8x, VERBATIM DVD+RW 4x  
VERBATIM DVD-R 8x, VERBATIM DVD-RW 2x, MAXELL DVD-R 16x, JVC DVD-RW 4x
- We strongly recommend for good recording quality:  
TDK DVD+R 4x/8x/16x, SONY DVD+R 4x/8x/16x, MAXELL DVD+R 4x/8x/16x, SONY DVD+RW 4x,  
MAXELL DVD-R 8x/16x, MAXELL DVD-RW 4x

Logo	Attributes	Logo	Attributes
	8cm/12cm, single-sided, single layer disc Approx. max. recording time (SLP mode): 360 minutes (4.7GB) (for 12cm) 108 minutes (1.4GB) (for 8cm)		8cm/12cm, single-sided, single layer disc Approx. max. recording time (SLP mode): 360 minutes (4.7GB) (for 12cm) 108 minutes (1.4GB) (for 8cm)

## 1

## Connections

### Remote Control

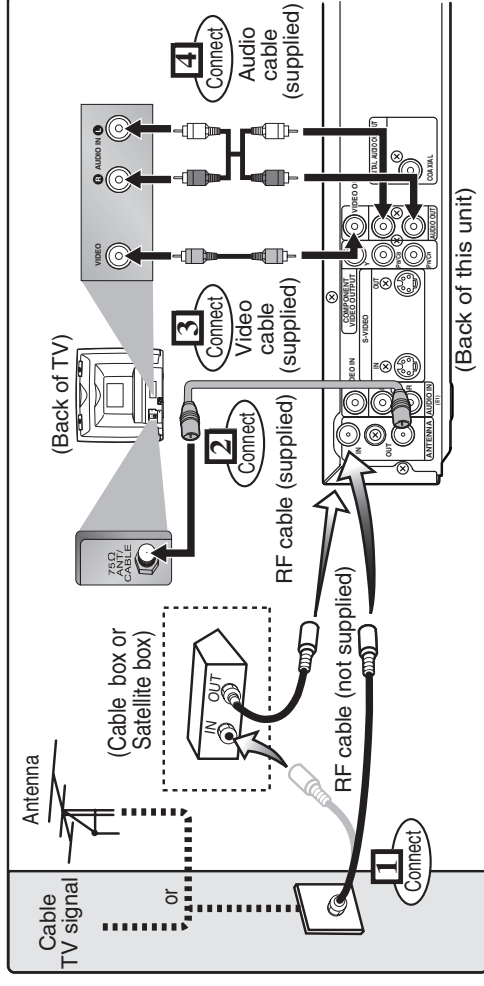
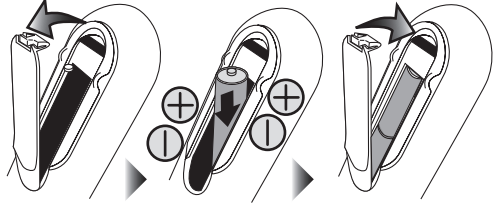

- Both AV and RF cables must be connected to the TV for operation.
- See front page of the Owner's Manual for the connection with the RF modulator.

## 2

## Setup

### 2-1 Watching on TV

Press [STANDBY-ON] to turn the unit on.

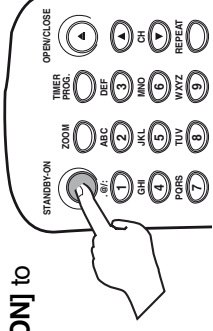

- Switch the input selector on your TV to an appropriate external input channel (usually near channel 0).
- Press a button on the TV's original remote control (see the table) to select an external input channel until the DVD recorder's picture appears.

### Input Mode Names for Common TV Brands

Brand	AUX	Panasonic	TV/VIDEO
Admiral	LINE1, LINE2, 00, 90, 91, 92, 93	RCA	INPUT, TV/VCR, 00, 90, 91, 92, 93
Curtis Mathis	INPUT, TV/VCR, 00, 90, 91, 92, 93	Samsung	TV/VIDEO
GE	INPUT, AUX	Sanyo	VIDEO
Hitachi	VIDEO, VIDEO1, VIDEO2, VIDEO3	Sharp	00
JVC	AUX	Sony	VIDEO1, VIDEO2, VIDEO3
Kenwood	00	Toshiba	TV/GAME
LXI-Series	AUX CHANNEL	Zenith	00
Magnavox			

### 2-2 Initial Setup

Set up the following items when turning on the unit for the first time.

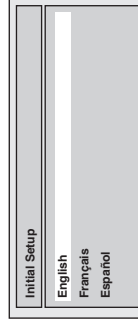

Using [▲/▼], select your desired language and press [OK].

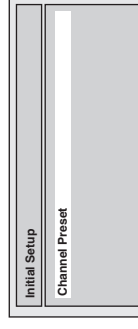

Press [OK] to Channel Preset. Then the unit will start getting available channels in your area.

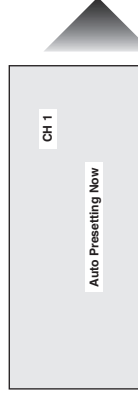

Using [▲/▼], enter the date (month / day / year). Press [◀/▶] to move the cursor. Press [OK]. TV Program will automatically appear. (usually near channel 0)

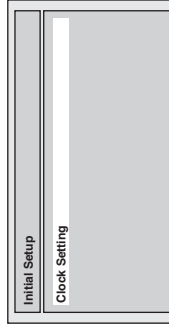

Press [OK] to Clock Setting.

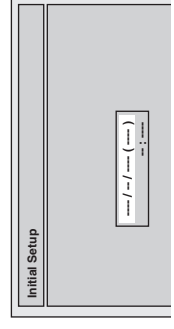

3-1 Easy Recording

Select the recording mode.

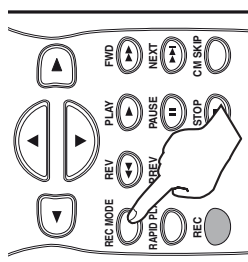

Select the desired channel.

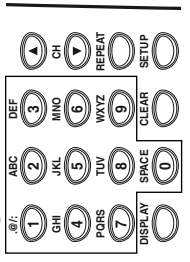

Record!

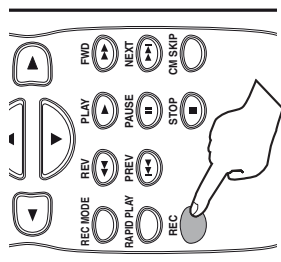

Stop the recording.

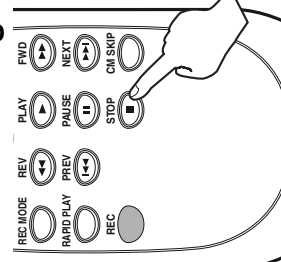

How to select the recording mode:

Disc Size	Recording mode	Recording time	Video/Sound Quality
8cm Disc	HQ (1Hr)	18 min	☆☆☆☆☆ (good)
	SP (2Hr)	36 min	☆☆☆☆☆
	SPP (2.5Hr)	45 min	☆☆☆☆☆
	LP (3Hr)	54 min	☆☆☆☆☆
	EP (4Hr)	72 min	☆☆☆☆☆
	SLP (6Hr)	108 min	☆
12cm Disc	HQ (1Hr)	60 min	☆☆☆☆☆ (good)
	SP (2Hr)	120 min	☆☆☆☆☆
	SPP (2.5Hr)	150 min	☆☆☆☆☆
	LP (3Hr)	180 min	☆☆☆☆☆
	EP (4Hr)	240 min	☆☆☆☆☆
	SLP (6Hr)	360 min	☆

Press repeatedly to select desired recording time.

Recording times appear on the TV screen (30 minutes to 6 hours). Recording will start.

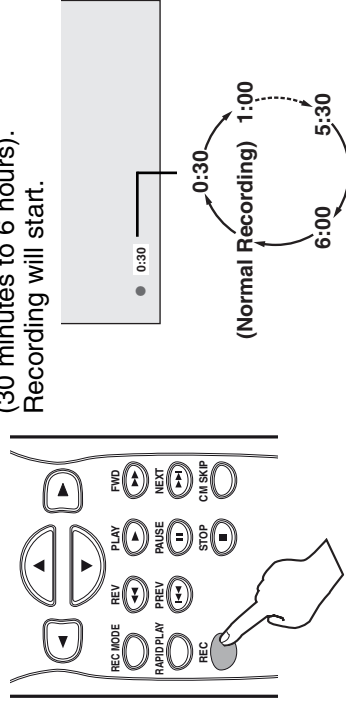

When the unit reaches the specified time, the unit will be turned off automatically.

After all recordings, finalize your disc!

Finalize DVD-RW/-R/+R discs after recording. Make edits compatible on DVD+RW discs after editing.

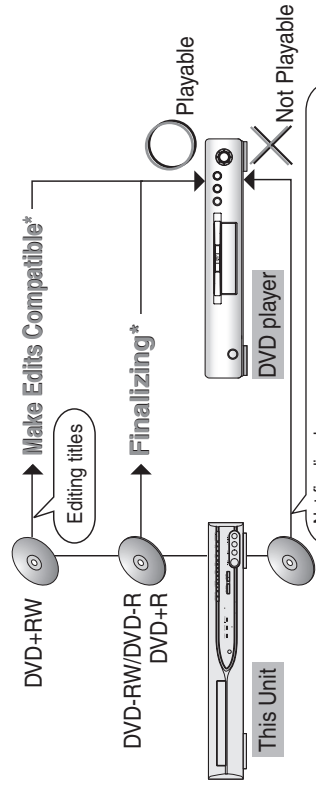

\*You cannot finalize or Make Edits Compatible in other DVD recorders.

3-2 Timer Recording

- You can set up to 8 programs (once, daily or weekly).
- Be sure to set the clock before starting a timer programming.

Press [TIMER PROG.].

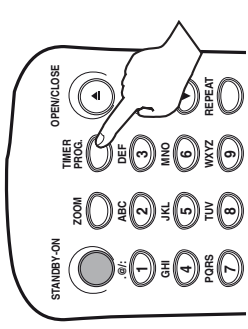

Timer Programming list appears. Select any blank line with [▲/▼] and press [OK].

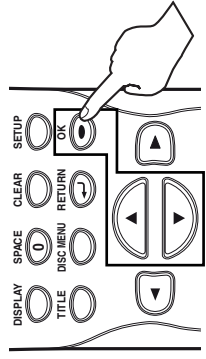
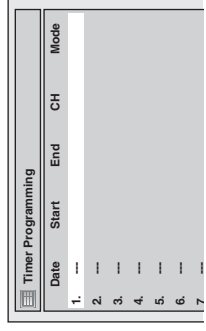

OK!

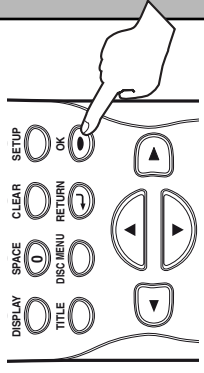

Timer Recording is now set.

Set the date.

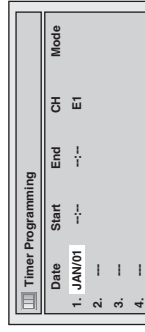

Select the channel number to record.

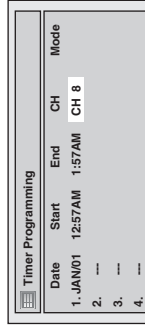

Turn off the unit to set the Timer Standby mode.

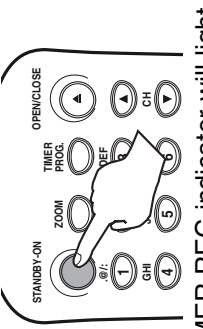

TIMER REC indicator will light up on the front panel.

Set start and end time.

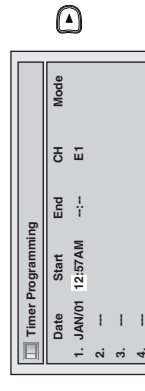

Select the recording mode.

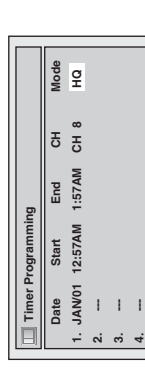

Open the disc tray.

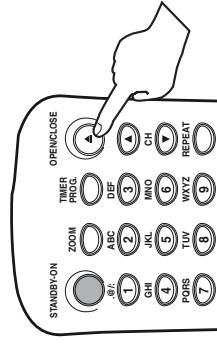

Insert a disc.

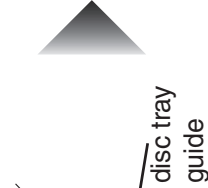
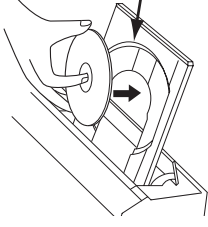

Play!

Stop playing.

If the title menu appears, using [▲/▼], select a title and press [OK]. (Then select "Play" with [▲/▼] when playing titles recorded by this unit.)